

WHP P6, A10, I3/I4 REVISIT DATA BOOK

Blue Earth Global Expedition 2003 (BEAGLE2003)

Volume 2

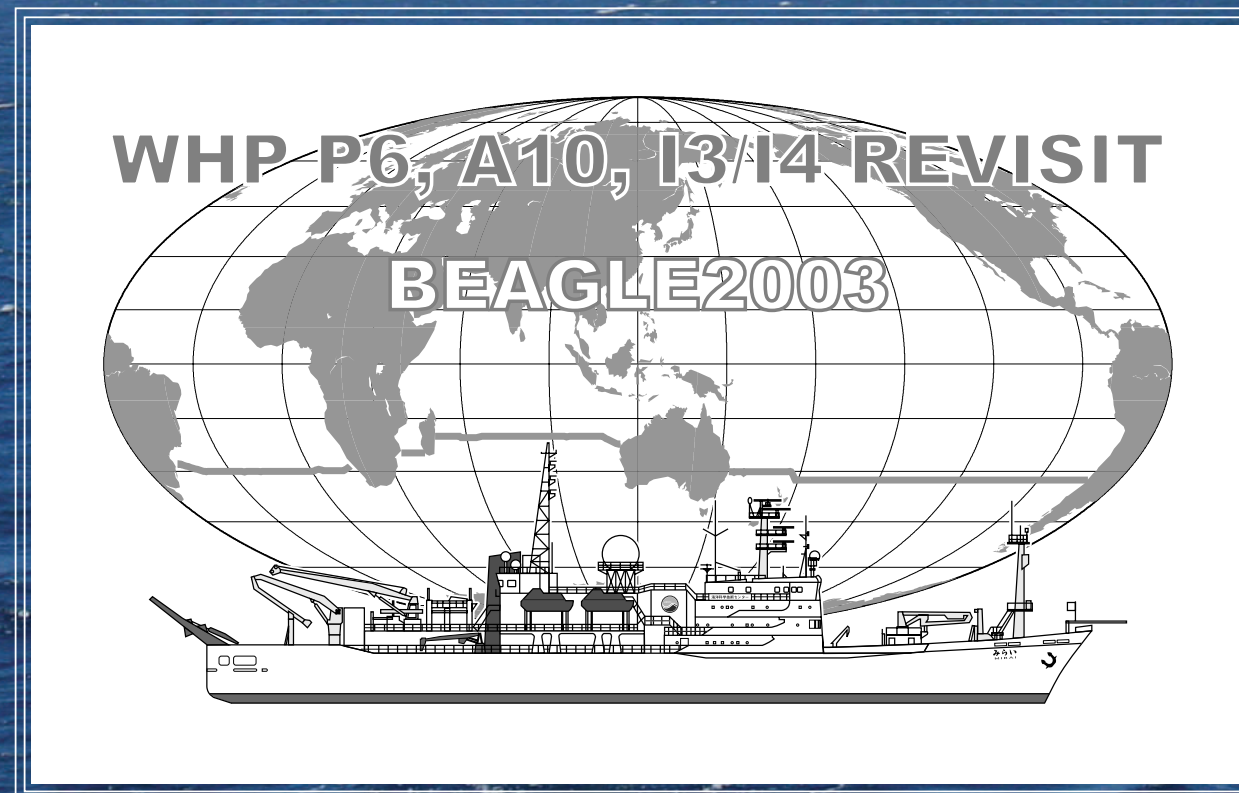

WHP P6, A10, I3/I4 REVISIT DATA BOOK

Blue Earth Global Expedition 2003 (BEAGLE2003)

Volume 2



Edited by

Hiroshi Uchida (JAMSTEC),

Masao Fukasawa (JAMSTEC)

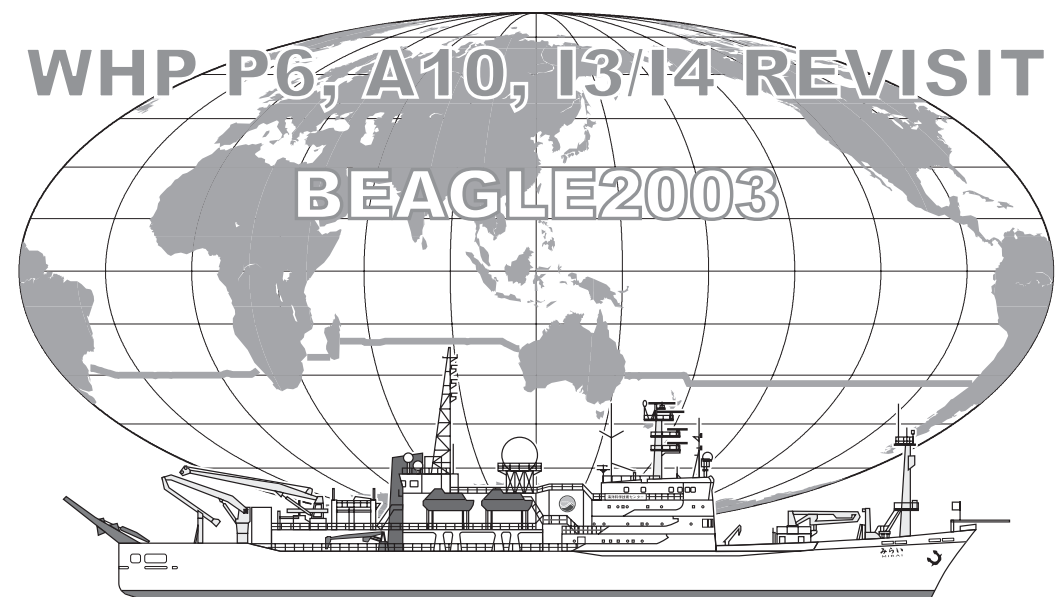

WHP P6, A10, I3/I4 REVISIT DATA BOOK

Blue Earth Global Expedition 2003 (BEAGLE2003)

Volume 2

10, March, 2005 Published

Edited by Hiroshi Uchida (JAMSTEC) and Masao Fukasawa (JAMSTEC)

Published by © JAMSTEC, Yokosuka, Kanagawa, 2005

Japan Agency for Marine-Earth Science and Technology

2-15 Natsushima, Yokosuka, Kanagawa. 237-0061, Japan

Phone +81-46-867-9474, Fax +81-46-867-9455

Printed by Aiwa Printing Co., Ltd.

3-22-4 Takanawa, Minato-ku, Tokyo 108-0074, Japan

Contents (Volume 2)

Documents

Hydrographic Measurement Techniques and Calibrations

<i>CTD/O₂</i>	1
<i>H. Uchida, M. Fukasawa (JAMSTEC),</i>	
<i>W. Schneider (Univ. of Concepcion), M. Rosenberg (ACE CRC),</i>	
<i>S. Ozawa, H. Matsunaga and K. Oyama (MWJ)</i>	
<i>Salinity</i>	40
<i>T. Kawano (JAMSTEC), T. Matsumoto, N. Takahashi (MWJ)</i>	
<i>and T. Watanabe (Nagasaki Univ.)</i>	
<i>Oxygen</i>	48
<i>Y. Kumamoto, S. Watanabe (JAMSTEC), A. Nishina (Kagoshima Univ.),</i>	
<i>K. Matsumoto (JAMSTEC), E. de Braga (Univ. of Sao Paulo),</i>	
<i>T. Seike, I. Yamazaki, T. Miyashita and N. Komai (MWJ)</i>	
<i>Nutrients</i>	57
<i>M. Aoyama (MRI/JMA), J. Hamanaka, A. Kubo, Y. Otsubo,</i>	
<i>K. Sato, A. Yasuda and S. Yokogawa (MWJ)</i>	
<i>Dissolved inorganic carbon (C_T)</i>	74
<i>A. Murata (JAMSTEC), M. Kitada, M. Kamata,</i>	
<i>M. Moro and T. Fujiki (MWJ)</i>	
<i>Total alkalinity (A_T)</i>	79
<i>A. Murata (JAMSTEC), F. Shibata and T. Ohama (MWJ)</i>	
<i>pH</i>	85
<i>A. Murata (JAMSTEC), F. Shibata and T. Ohama (MWJ)</i>	
<i>Lowered Acoustic Doppler Current Profiler</i>	88
<i>Y. Yoshikawa (JAMSTEC), L. Nonnato (Univ. of Sao Paulo)</i>	
<i>and O. Sugimoto (JAMSTEC)</i>	

Figures

<i>Figure caption</i>	90
<i>Observation lines</i>	93
<i>Station locations</i>	94
<i>Cross-sections</i>	
<i>Potential temperature</i>	96
<i>Salinity</i>	98
<i>Salinity (with SSW correction)</i>	100
<i>Density (σ_{θ})</i>	102
<i>Density (σ_t)</i>	104
<i>Neutral density (γ^n)</i>	106
<i>Oxygen</i>	108
<i>Silicate</i>	110
<i>Nitrate</i>	112
<i>Nitrite</i>	114
<i>Phosphate</i>	116
<i>Dissolved inorganic carbon</i>	118
<i>Total alkalinity</i>	120
<i>pH</i>	122
<i>Difference between WOCE and BEAGLE2003</i>	
<i>Potential temperature</i>	124
<i>Salinity (with SSW correction)</i>	126
<i>Oxygen</i>	128

3 Hydrographic Measurement Techniques and Calibrations

3.1 CTD/O₂

28 February 2005

(1) Personnel

Hiroshi Uchida (JAMSTEC)

Masao Fukasawa (JAMSTEC)

Wolfgang Schneider (University of Concepcion)

Mark Rosenberg (ACE CRC)

Satoshi Ozawa (MWJ)

Hiroshi Matsunaga (MWJ)

Kentaro Oyama (MWJ)

(2) Winch arrangements

The CTD package was deployed using 4.5 Ton Traction Winch System (Dynacon, Inc., USA) which was installed on the R/V Mirai in April 2001. The CTD Traction Winch System with the Heave Compensation Systems (Dynacon, Inc., USA) is designed to reduce cable stress resulting from load variation caused by wave or vessel motion. The system is operated passively by providing a nodding boom crane that moves up or down in response to line tension variations. Primary system components include a complete CTD Traction Winch System with up to 10 km of 9.53 mm armored cable (Ocean Cable and Communication Co.), cable rocker and Electro-Hydraulic Power Unit, nodding-boom crane assembly, two hydraulic cylinders and two hydraulic oil/nitrogen accumulators mounted within a single frame assembly. The system also contains related electronic hardware interface and a heave compensation computer control program.

(3) Overview of the equipment

The CTD system, SBE 911plus system (Sea-Bird Electronics, Inc., USA), is a real time data system with

the CTD data transmitted from a SBE 9plus underwater unit via a conducting cable to the SBE 11plus deck unit. The SBE 11plus deck unit is a rack-mountable interface which supplies DC power to the underwater unit, decodes the serial data stream, formats the data under microprocessor control, and passes the data to a companion computer. The serial data from the underwater unit is sent to the deck unit in RS-232 NRZ format using a 34,560 Hz carrier-modulated differential-phase-shift-keying (DPSK) telemetry link. The deck unit decodes the serial data and sends them to a personal computer to display, at the same time, to storage in a disk file using SBE SEASOFT software.

The SBE 911plus system acquires data from primary, secondary and auxiliary sensors in the form of binary numbers corresponding to the frequency or voltage outputs from those sensors at 24 samples per second. The calculations required to convert from raw data to engineering units of the parameters are performed by the SBE SEASOFT in real-time. The same calculations can be carried out after the observation using data stored in a disk file.

The SBE 911plus system controls the 36-position SBE 32 Carousel Water Sampler. The Carousel accepts 12-litre water sample bottles. Bottles were fired through the RS-232C modem connector on the back of the SBE 11plus deck unit while acquiring real time data. The 12-litre Niskin-X water sample bottle (General Oceanics, Inc., USA) is equipped externally with two stainless steel springs. The external springs are ideal for applications such as the trace metal analysis because the inside of the sampler is free from contaminants from springs.

SBE's temperature (SBE 3) and conductivity (SBE 4) sensor modules were used with the SBE 9plus underwater unit fixed by a single clamp and "L" bracket to the lower end cap. The conductivity cell entrance is co-planar with the tip of the temperature sensor's protective steel sheath. The pressure sensor is mounted in the main housing of the underwater unit and is ported to outside through the oil-filled plastic capillary tube. A compact, modular unit consisting of a centrifugal pump head and a brushless DC ball bearing motor contained in an aluminum underwater housing pump (SBE 5T) flushes water through sensor tubing at a constant rate independent of the CTD's motion. Motor speed and pumping rate (3,000 rpm) remain nearly constant over the entire input voltage range of 12-18 volts DC. Flow speed of pumped water in standard TC duct is about 2.4 m/s.

SBE's dissolved oxygen sensor (SBE 43) was placed between the conductivity sensor module and the pump. Auxiliary sensors, Deep Ocean Standards Thermometer (SBE 35), altimeter and fluorometer, were also used with the SBE 9plus underwater unit. The SBE 35 position in regard to the SBE 3 is shown in Figure 3.1.1.

It is known that the CTD temperature data is influenced by the motion (pitching and rolling) of the CTD package. In order to reduce the motion of the CTD package, a heavy stainless frame (total weight of the CTD package without sea water in the bottles is about 1,000 kg) was used and an aluminum plate (54 x 90 cm) was attached to the frame (Figure 3.1.2).

Summary of the system used in this cruise

Leg 1

Deck unit:

SBE, Inc., SBE 11plus, S/N 0272

Under water unit:

SBE, Inc., SBE 9plus, S/N 79492 (Pressure sensor: S/N 0575)

Temperature sensor:

SBE, Inc., SBE 3plus, S/N 4188 (primary)

SBE, Inc., SBE 3, S/N 1464 (secondary)

Conductivity sensor:

SBE, Inc., SBE 4, S/N 1088 (primary)

SBE, Inc., SBE 4, S/N 1202 (secondary)

Oxygen sensor:

SBE, Inc., SBE 43, S/N 0390 (primary)

SBE, Inc., SBE 43, S/N 0205 (secondary)

Pump:

SBE, Inc., SBE 5T, S/N 3575 (primary)

SBE, Inc., SBE 5T, S/N 0984 (secondary)

Altimeter:

Benthos Inc., PSA-900D, S/N 1026 (except for P06_148)

Benthos Inc., 2110-2, S/N 206 (P06_148)

Deep Ocean Standards Thermometer:

SBE, Inc., SBE 35, S/N 0022

Fluorometer:

Seapoint sensors, Inc., S/N 2148 (from P06_246 to P06_166 cast 1)

(no fluorometer from P06_166 cast 2 to P06_004)

Carousel Water Sampler:

SBE, Inc., SBE 32, S/N 0278

Water sample bottle:

General Oceanics, Inc., 12-litre Niskin-X (no TEFLON coating)

Leg 2

Deck unit:

SBE, Inc., SBE 11plus, S/N 0272

Under water unit:

SBE, Inc., SBE 9plus, S/N 42423 (Pressure sensor: S/N 0357)

Temperature sensor:

SBE, Inc., SBE 3, S/N 1524 (primary, P06_127)

SBE, Inc., SBE 3plus, S/N 4216 (primary, from P06_125 to P06_004)

SBE, Inc., SBE 3plus, S/N 2453 (secondary)

Conductivity sensor:

SBE, Inc., SBE 4, S/N 2240 (primary)

SBE, Inc., SBE 4, S/N 1206 (secondary)

Oxygen sensor:

SBE, Inc., SBE 43, S/N 0391 (primary)

SBE, Inc., SBE 43, S/N 0069 (secondary, from P06_127 to P06_061)

(no secondary sensor from P06_060 to P06_004)

Pump:

SBE, Inc., SBE 5T, S/N 3575 (primary)

SBE, Inc., SBE 5T, S/N 0984 (secondary)

Altimeter:

Benthos Inc., PSA-900D, S/N 1026

Deep Ocean Standards Thermometer:

SBE, Inc., SBE 35, S/N 0022

Fluorometer:

None

Carousel Water Sampler:

SBE, Inc., SBE 32, S/N 0278

Water sample bottle:

General Oceanics, Inc., 12-litre Niskin-X (no TEFLON coating)

Leg 4

Deck unit:

SBE, Inc., SBE 11plus, S/N 0272

Under water unit:

SBE, Inc., SBE 9plus, S/N 42423 (Pressure sensor: S/N 0357)

Temperature sensor:

SBE, Inc., SBE 3, S/N 1464 (primary)

SBE, Inc., SBE 3plus, S/N 4188 (secondary)

Conductivity sensor:

SBE, Inc., SBE 4, S/N 1203 (primary)

SBE, Inc., SBE 4, S/N 2435 (secondary)

Oxygen sensor:

SBE, Inc., SBE 43, S/N 0391 (primary)

SBE, Inc., SBE 43, S/N 0394 (secondary)

Pump:

SBE, Inc., SBE 5T, S/N 3575 (primary)

SBE, Inc., SBE 5T, S/N 0984 (secondary)

Altimeter:

Benthos Inc., PSA-900D, S/N 1026

Deep Ocean Standards Thermometer:

SBE, Inc., SBE 35, S/N 0045

Fluorometer:

Seapoint sensors, Inc., S/N 2579

Carousel Water Sampler:

SBE, Inc., SBE 32, S/N 0391

Water sample bottle:

General Oceanics, Inc., 12-litre Niskin-X (no TEFLON coating)

Leg 5

Deck unit:

SBE, Inc., SBE 11plus, S/N 0272 (from I04_610 to I03_467)

SBE, Inc., SBE 11plus, S/N 0344 (from I03_466 to I03_444)

Under water unit:

SBE, Inc., SBE 9plus, S/N 42423 (Pressure sensor: S/N 0357)

Temperature sensor:

SBE, Inc., SBE 3, S/N 1464 (primary)

SBE, Inc., SBE 3, S/N 4323 (secondary)

Conductivity sensor:

SBE, Inc., SBE 4, S/N 1088 (primary, from I04_610 to I03_503)

SBE, Inc., SBE 4, S/N 2435 (primary, from I03_502 to I03_444)

SBE, Inc., SBE 4, S/N 1202 (secondary)

Oxygen sensor:

SBE, Inc., SBE 43, S/N 0391 (primary)

SBE, Inc., SBE 43, S/N 0205 (secondary)

Pump:

SBE, Inc., SBE 5T, S/N 3575 (primary)

SBE, Inc., SBE 5T, S/N 0984 (secondary)

Altimeter:

Benthos Inc., PSA-900D, S/N 1026 (from I04_610 to I03_511)

Benthos Inc., PSA-900D, S/N 0396

(from I03_510 to I03_469, I03_466, I03_467,

from I03_463 to I03_444)

Benthos Inc., 2110-2, S/N 206 (from I03_468 to I03_467, I03_464)

Deep Ocean Standards Thermometer:

SBE, Inc., SBE 35, S/N 0045

Fluorometer:

Seapoint sensors, Inc., S/N 2579

Carousel Water Sampler:

SBE, Inc., SBE 32, S/N 0391 (from I04_610 to I03_514)

SBE, Inc., SBE 32, S/N 0278 (from I03_513 to I03_444)

Water sample bottle:

General Oceanics, Inc., 12-litre Niskin-X (no TEFLON coating)

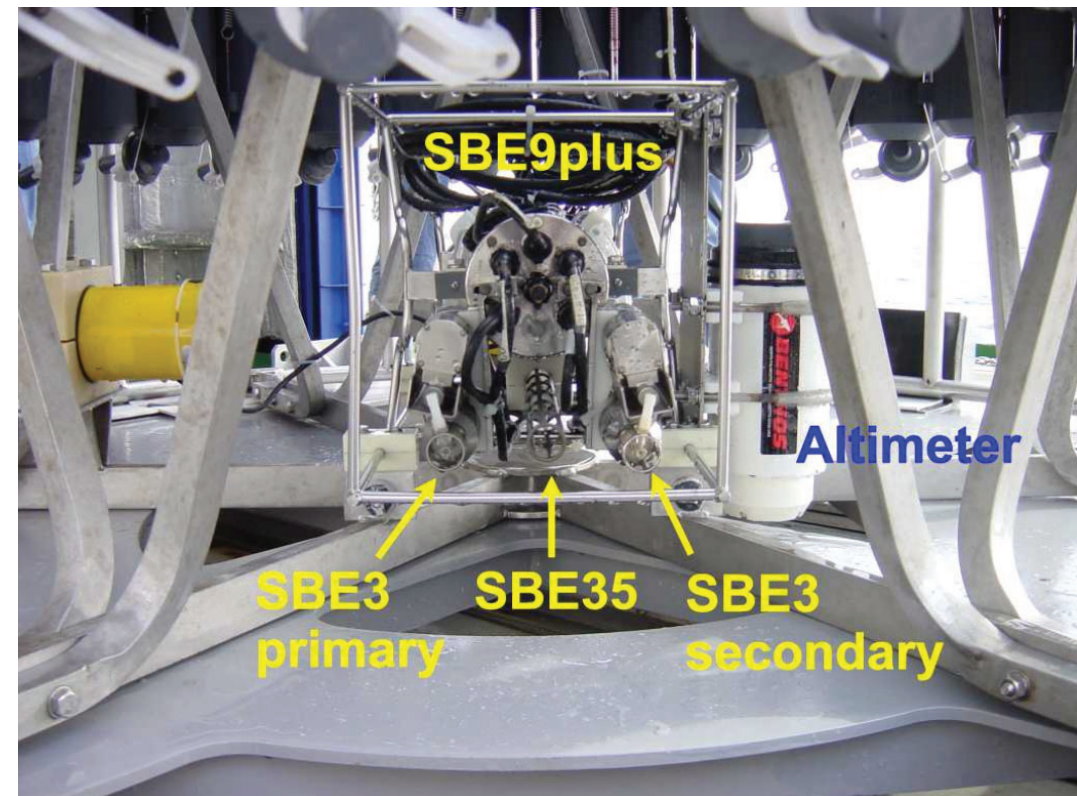

Figure 3.1.1. The SBE 35 position in regard to the SBE 3 temperature sensors.

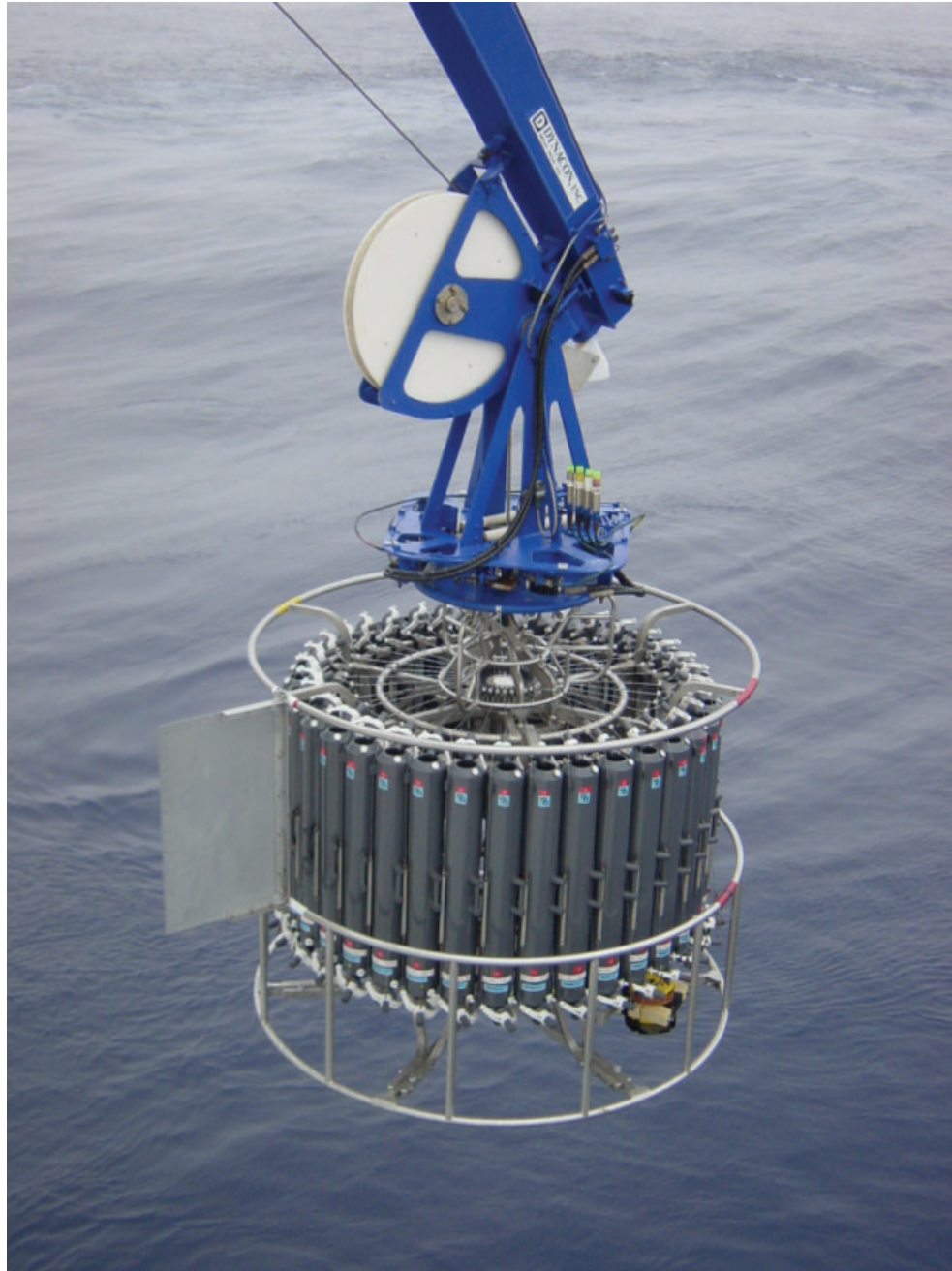

Figure 3.1.2. The CTD package.

(4) Pre-cruise calibration

(4.1) Pressure

The Paroscientific series 4000 Digiquartz high pressure transducer (Paroscientific, Inc., USA) uses a quartz crystal resonator whose frequency of oscillation varies with pressure induced stress with 0.01 per million of resolution over the absolute pressure range of 0 to 15,000 psia (0 to 10,332 dbar). Also, a quartz crystal temperature signal is used to compensate for a wide range of temperature changes at the time of an observation. The pressure sensor (MODEL 415K-187) has a nominal accuracy of 0.015 % FS (1.5 dbar), typical stability of 0.0015 % FS/month (0.15 dbar/month) and resolution of 0.001 % FS (0.1 dbar).

Pre-cruise sensor calibrations were performed at SBE, Inc., USA. The following coefficients were used in the SEASOFT:

S/N 0575 (Leg 1), 27 October 1999

$$c_1 = -65706.8$$

$$c_2 = -0.1758329$$

$$c_3 = 2.04245e-02$$

$$d_1 = 0.027146$$

$$d_2 = 0.0$$

$$t_1 = 29.92375$$

$$t_2 = -2.63869e-04$$

$$t_3 = 3.92132e-06$$

$$t_4 = 1.35947e-09$$

$$t_5 = 4.49704e-12$$

(The coefficients c_1 , c_2 , t_1 and t_2 were changed on 6 December 1999.)

S/N 0357 (Leg 2, 4 and 5), 17 May 1994

$$c_1 = -69582.91$$

$$c_2 = -1.619244$$

$$c_3 = 2.34327e-02$$

$$d_1 = 0.029679$$

$$d_2 = 0$$

$$t_1 = 28.12082$$

$$t_2 = -4.595919e-04$$

$$t_3 = 3.89464e-06$$

$$t_4 = 0$$

$$t_5 = 0$$

Pressure coefficients are first formulated into

$$c = c_1 + c_2 * U + c_3 * U^2$$

$$d = d_1 + d_2 * U$$

$$t_0 = t_1 + t_2 * U + t_3 * U^2 + t_4 * U^3 + t_5 * U^4$$

where U is temperature in degrees Celsius. The pressure temperature, U, is determined according to

$$U (^{\circ}\text{C}) = M * (12 \text{ bit pressure temperature compensation word}) - B$$

The following coefficients were used in SEASOFT:

S/N 0575 (Leg 1)

$$M = 0.01284934$$

$$B = -8.388034$$

(in the underwater unit system configuration sheet dated on 30 November 1999)

S/N 0357 (Leg 2, 4 and 5)

$$M = 0.01161$$

$$B = -8.32759$$

(in the underwater unit system configuration sheet dated on 24 May 1994)

Finally, pressure is computed as

$$P (\text{psi}) = c * [1 - (t_0^2 / t^2)] * \{1 - d * [1 - (t_0^2 / t^2)]\}$$

where t is pressure period (μsec). Since the pressure sensor measures the absolute value, it inherently includes atmospheric pressure (about 14.7 psi). SEASOFT subtracts 14.7 psi from computed pressure above automatically.

Pressure sensor calibrations against a dead-weight piston gauge (Bundenberg Gauge Co. Ltd., UK; Model 480DA, S/N 23906) are performed at JAMSTEC (Yokosuka, Kanagawa, JAPAN) by Marine Works Japan Ltd. (MWJ), usually once in a year in order to monitor sensor time drift and linearity. The pressure sensor drift is known to be primarily an offset drift at all pressures rather than a change of span slope. The pressure sensor hysteresis is typically 0.2 dbar. The following coefficients for the sensor drift correction were also used in SEASOFT through the software module SEACON:

S/N 0575 (Leg 1), 21 April 2003

$$\text{slope} = 0.9999235$$

$$\text{offset} = 2.4157361$$

S/N 0357 (Leg 2, 4 and 5), 18 April 2003

$$\text{slope} = 0.9999112$$

$$\text{offset} = -0.0295469$$

The drift-corrected pressure is computed as

$$\text{Drift-corrected pressure (dbar)} = \text{slope} * (\text{computed pressure in dbar}) + \text{offset}$$

Results of the pressure sensor calibrations against the dead weight piston gauge are shown in Figure 3.1.3 and 3.1.4.

Time drifts of the pressure sensors based on the offset of the calibrations are also shown in Figure 3.1.5 and 3.1.6.

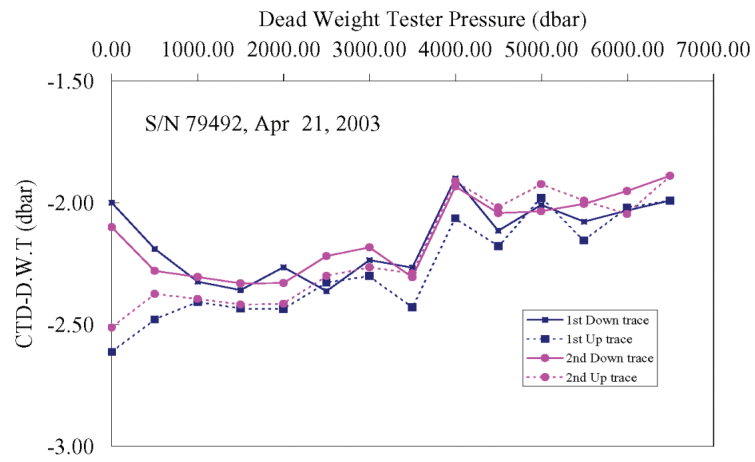

Figure 3.1.3. The residual pressures between the dead weight piston gauge and the CTD pressure (S/N 0575).

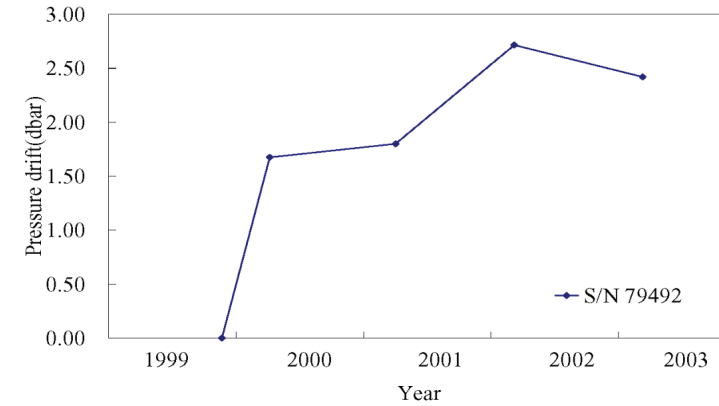

Figure 3.1.5. Pressure sensor (S/N 0575) time drift based on laboratory calibrations performed by MWJ.

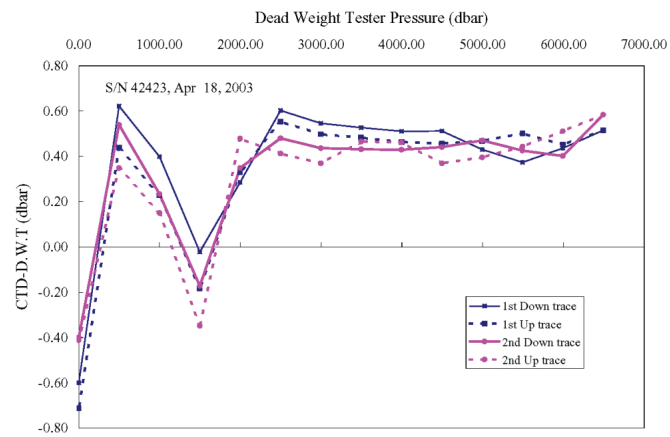

Figure 3.1.4. Same as Figure 3.1.3, but for the pressure sensor S/N 0357.

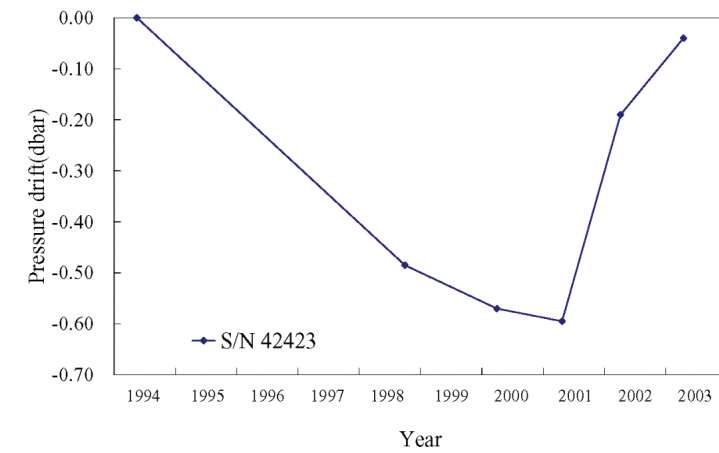

Figure 3.1.6. Same as Figure 3.1.5, but for the pressure sensor S/N 0357.

(4.2) Temperature (SBE 3)

The temperature sensing element is a glass-coated thermistor bead in a stainless steel tube, providing a pressure-free measurement at depths up to 10,500 (6,800) meters by titanium (aluminum) housing. The sensor output frequency ranges from approximately 5 to 13 kHz corresponding to temperature from -5 to 35 °C. The output frequency is inversely proportional to the square root of the thermistor resistance, which controls the output of a patented Wien Bridge circuit. The thermistor resistance is exponentially related to temperature. The SBE 3 thermometer has a nominal accuracy of 0.001 °C, typical stability of 0.0002 °C/month and resolution of 0.0002 °C at 24 samples per second. The premium temperature sensor, SBE 3plus, is a more rigorously tested and calibrated version of standard temperature sensor (SBE 3). A sensor is designated as an SBE 3plus only after demonstrating drift of less than 0.001 °C during a six-month screening period. In addition, the time response is carefully measured and verified to be 0.065 ± 0.010 seconds.

Pre-cruise sensor calibrations were performed at SBE, Inc., USA. The following coefficients were used in SEASOFT:

S/N 4188 (Leg 1), 25 June 2003

$$\begin{aligned}g &= 4.39868209e-03 \\h &= 6.45272514e-04 \\i &= 2.26066338e-05 \\j &= 1.89127504e-06 \\f_0 &= 1000.000\end{aligned}$$

S/N 1464 (Leg 1), 24 June 2003

$$\begin{aligned}g &= 4.84388979e-03 \\h &= 6.80795615e-04 \\i &= 2.70029675e-05 \\j &= 2.13380253e-06 \\f_0 &= 1000.000\end{aligned}$$

S/N 1524 (Leg 2), 15 April 2003

$$\begin{aligned}g &= 4.85928482e-03 \\h &= 6.85560499e-04 \\i &= 2.72682203e-05 \\j &= 2.04591608e-06 \\f_0 &= 1000.000\end{aligned}$$

S/N 4216 (Leg 2), 29 July 2003

$$\begin{aligned}g &= 4.35956769e-03 \\h &= 6.45664029e-04 \\i &= 2.25867675e-05 \\j &= 1.88325427e-06 \\f_0 &= 1000.000\end{aligned}$$

S/N 2453 (Leg 2), 25 July 2003

$$\begin{aligned}g &= 4.4010773e-03 \\h &= 6.47307314e-04 \\i &= 2.32721826e-05 \\j &= 2.09881293e-06 \\f_0 &= 1000.000\end{aligned}$$

S/N 1464 (Leg 4 and 5), 23 September 2003

$$\begin{aligned}g &= 4.84390595e-03 \\h &= 6.80838076e-04 \\i &= 2.70300539e-05 \\j &= 2.13906165e-06 \\f_0 &= 1000.000\end{aligned}$$

S/N 4188 (Leg 4), 23 September 2003

$$g = 4.39869651e-03$$

$$h = 6.45292266e-04$$

$$i = 2.26138218e-05$$

$$j = 1.89143037 e-06$$

$$f_0 = 1000.000$$

S/N 4323 (Leg 5), 29 October 2003

$$g = 4.36386026e-03$$

$$h = 6.48493108e-04$$

$$i = 2.28715193e-05$$

$$j = 1.84823185 e-06$$

$$f_0 = 1000.000$$

Temperature (ITS-90) is computed according to

$$\text{Temperature (ITS-90)} =$$

$$1 / \{g + h * [\ln(f_0 / f)] + i * [\ln^2(f_0 / f)] + j * [\ln^3(f_0 / f)]\} - 273.15$$

where f is the instrument frequency (kHz).

(4.3) Conductivity (SBE 4)

The flow-through conductivity sensing element is a glass tube (cell) with three platinum electrodes to provide in-situ measurements at depths up to 10,500 meters. The impedance between the center and the end electrodes is determined by the cell geometry and the specific conductance of the fluid within the cell. The conductivity cell composes a Wien Bridge circuit with other electric elements of which frequency output is approximately 3 to 12 kHz corresponding to conductivity of the fluid of 0 to 7 S/m. The conductivity cell SBE 4 has a nominal accuracy of 0.0003 S/m, typical stability of 0.0003 S/m/month and resolution of 0.00004 S/m at 24 samples per second.

Pre-cruise sensor calibrations were performed at SBE, Inc., USA. The following coefficients were used in SEASOFT:

S/N 1088 (Leg 1), 3 July 2003

$$g = -4.01946189e+00$$

$$h = 5.50802658e-01$$

$$i = -1.68736617e-04$$

$$j = 3.83962022e-05$$

$$\text{CPcor} = -9.57e-08 \text{ (nominal)}$$

$$\text{CTcor} = 3.25e-06 \text{ (nominal)}$$

S/N 1202 (Leg 1), 3 July 2003

$$g = -3.94210124e+00$$

$$h = 4.38993142e-01$$

$$i = -9.59762118e-06$$

$$j = 2.09906225e-05$$

$$\text{CPcor} = -9.57e-08 \text{ (nominal)}$$

$$\text{CTcor} = 3.25e-06 \text{ (nominal)}$$

S/N 2240 (Leg 2), 30 July 2003

$$g = -1.06122361e+01$$

$$h = 1.51071990e+00$$

$$i = -2.24813805e-03$$

$$j = 2.43876786e-04$$

$$\text{CPcor} = -9.57e-08 \text{ (nominal)}$$

$$\text{CTcor} = 3.25e-06 \text{ (nominal)}$$

S/N 1206 (Leg 2), 30 July 2003

$$g = -4.29002369e+00$$

h = 5.03379521e-01
i = 1.18152789e-04
j = 2.02164093e-05
CPcor = -9.57e-08 (nominal)
CTcor = 3.25e-06 (nominal)

S/N 1203 (Leg 4), 25 September 2003

g = -4.05196392e+00
h = 4.93501401e-01
i = 8.12083631e-05
j = 2.24962840e-05
CPcor = -9.57e-08 (nominal)
CTcor = 3.25e-06 (nominal)

S/N 2453 (Leg 4 and 5), 23 September 2003

g = -1.03013001e+00
h = 1.49755131e+00
i = 2.74099344e-04
j = 6.35607354e-05
CPcor = -9.57e-08 (nominal)
CTcor = 3.25e-06 (nominal)

S/N 1088 (Leg 5), 4 November 2003

g = -4.02167245e+00
h = 5.51410012e-01
i = -2.94330837e-04
j = 4.48686818e-05
CPcor = -9.57e-08 (nominal)
CTcor = 3.25e-06 (nominal)

S/N 1202 (Leg 5), 4 November 2003

g = -3.94477408e+00
h = 4.39537561e-01
i = -8.82455063e-05
j = 2.54499450e-05
CPcor = -9.57e-08 (nominal)
CTcor = 3.25e-06 (nominal)

Conductivity of a fluid in the cell is expressed as:

$$C \text{ (S/m)} = (g + h * f^2 + i * f^3 + j * f^4) / [10 (1 + CTcor * t + CPcor * p)]$$

where f is the instrument frequency (kHz), t is the water temperature (°C) and p is the water pressure (dbar).

The value of conductivity at salinity of 35, temperature of 15 °C (IPTS-68) and pressure of 0 dbar is 4.2914 S/m.

(4.4) Oxygen (SBE 43)

The SBE 43 oxygen sensor uses a Clark polarographic element to provide in-situ measurements at depths up to 7,000 meters. Calibration stability is improved by an order of magnitude and pressure hysteresis is largely eliminated in the upper ocean (1,000 m) compared with the previous oxygen sensor (SBE 13). Continuous polarization eliminates the wait-time for stabilization after power-up. Signal resolution is increased by on-board temperature compensation. The oxygen sensor is also included in the path of pumped sea water. The oxygen sensor determines the dissolved oxygen concentration by counting the number of oxygen molecules per second (flux) that diffuse through a membrane, where the permeability of the membrane to oxygen is a function of temperature and ambient pressure. Computation of dissolved oxygen in engineering units is done in SEASOFT software. The range for dissolved oxygen is 120 % of surface saturation in all natural waters; nominal accuracy is 2 % of saturation; typical stability is 2 % per 1,000 hours.

Pre-cruise sensor calibrations were performed at SBE, Inc., USA. The following coefficients were used in SEASOFT:

S/N 0390 (Leg 1), 14 July 2003

Soc = 0.3158
TCor = 0.0019
PCor = 1.350e-04
Offset = -0.5041

S/N 0205 (Leg 1), 18 June 2003

Soc = 0.3982
TCor = 0.0003
PCor = 1.350e-04
Offset = -0.4885

S/N 0391 (Leg 2, 4 and 5), 17 July 2003

Soc = 0.4108
TCor = 0.0012
PCor = 1.350e-04
Offset = -0.4851

S/N 0069 (Leg 2), 7 August 2003

Soc = 0.3001
TCor = 0.0009
PCor = 1.350e-04
Offset = 0.5984

S/N 0394 (Leg 4), 6 October 2003

Soc = 0.3003
TCor = 0.0016
PCor = 1.350e-04
Offset = 0.5016

S/N 0205 (Leg 5), 17 November 2003

Soc = 0.3982
TCor = 0.0002
PCor = 1.350e-04
Offset = -0.4808

Oxygen (ml/l) is computed as

$$\text{Oxygen (ml/l)} = \{\text{Soc} * (v + \text{offset})\} * \exp(\text{TCor} * t + \text{PCor} * p) * \text{Oxsat}(t, s)$$

$$\text{Oxsat}(t, s) = \exp[A_1 + A_2 * (100 / t) + A_3 * \ln(t / 100) + A_4 * (t / 100) + s * \{B_1 + B_2 * (t / 100) + B_3 * (t / 100) * (t / 100)\}]$$

$$A_1 = -173.4292$$

$$A_2 = 249.6339$$

$$A_3 = 143.3483$$

$$A_4 = -21.8482$$

$$B_1 = -0.033096$$

$$B_2 = -0.00170$$

where p is pressure in dbar, t is absolute temperature and s is salinity in psu. Oxsat is oxygen saturation value minus the volume of oxygen gas (STP) absorbed from humidity-saturated air.

(4.5) Deep Ocean Standards Thermometer

The Deep Ocean Standards Thermometer (SBE 35) is an accurate, ocean-range temperature sensor that can be standardized against Triple Point of Water and Gallium Melt Point cells and is also capable of measuring temperature in the ocean to depths of 6,800 m.

Temperature is determined by applying an AC excitation to reference resistances and an ultrastable aged thermistor with a drift rate of less than 0.001 °C/year. Each of the resulting outputs is digitized by a 20-bit A/D converter. The reference resistor is a hermetically sealed, temperature-controlled VISHAY. The switches are

mercury wetted reed relays with a stable contact resistance. AC excitation and ratiometric comparison using a common processing channel removes measurement errors due to parasitic thermocouples, offset voltages, leakage currents, and gain errors. Maximum power dissipated in the thermistor is 0.5 μ watts, and contributes less than 200 μ K of overheat error.

The SBE 35 communicates via a standard RS-232 interface at 300 baud, 8 bits, no parity. The SBE 35 can be used with the SBE 32 Carousel Water Sampler and SBE 911plus CTD system. The SBE 35 makes a temperature measurement each time a bottle fire confirmation is received, and stores the value in EEPROM. Calibration coefficients stored in EEPROM allow the SBE 35 to transmit data in engineering units. Commands can be sent to SBE 35 to provide status display, data acquisition setup, data retrieval, and diagnostic test using terminal software.

Following the methodology used for standards-grade platinum resistance thermometers (SPRT), the calibration of the SBE 35 is accomplished in two steps. The first step is to characterize and capture the non-linear resistance vs temperature response of the sensor. The SBE 35 calibrations are performed at SBE, Inc., in a low-gradient temperature bath and against ITS-90 certified SPRTs maintained at Sea-Bird's primary temperature metrology laboratory. The second step is frequent certification of the sensor by measurements in thermodynamic fixed-point cells. Triple point of water (TPW) and gallium melt point (GaMP) cells are appropriate for the SBE 35. The SBE 35 resolves temperature in the fixed-point cells to approximately 25 μ K. Like SPRTs, the slow time drift of the SBE 35 is adjusted by a slope and offset correction to the basic non-linear calibration equation.

Pre-cruise sensor calibrations were performed at SBE, Inc., USA. The following coefficients were stored in EEPROM:

S/N 0022 (Leg 1 and 2), 12 October 1999 (1st step: linearization)

$$a_0 = 4.320725498e-3$$

$$a_1 = -1.189839279e-3$$

$$a_2 = 1.836299593e-3$$

$$a_3 = -1.032916769e-5$$

$$a_4 = 2.225491125e-7$$

S/N 0045 (Leg 4 and 5), 27 October 2002 (1st step: linearization)

$$a_0 = 5.84093815e-03$$

$$a_1 = -1.65529280e-03$$

$$a_2 = 2.37944937e-04$$

$$a_3 = -1.32611385e-05$$

$$a_4 = 2.83355203e-07$$

Linearized temperature (ITS-90) is computed according to

Linearized temperature (ITS-90) =

$$1 / \{a_0 + a_1 * [\ln(n)] + a_2 * [\ln^2(n)] + a_3 * [\ln^3(n)] + a_4 * [\ln^4(n)]\} - 273.15$$

where n is the instrument output. Then the SBE 35 is certified by measurements in thermodynamic fixed-point cells of the TPW (0.0100 °C) and GaMP (29.7646 °C). Like SPRTs, the slow time drift of the SBE 35 is adjusted by periodic recertification corrections.

S/N 0022 (Leg 1 and 2), 26 March 2003 (2nd step: fixed point calibration)

$$\text{Slope} = 1.000012$$

$$\text{Offset} = 0.000052$$

S/N 0045 (Leg 4 and 5), 26 September 2003 (2nd step: fixed point calibration)

$$\text{Slope} = 1.000007$$

$$\text{Offset} = -0.000376$$

Temperature (ITS-90) is calibrated according to

$$\text{Temperature (ITS-90)} = \text{Slope} * \text{Linearized temperature} + \text{Offset}$$

The SBE 35 has a time constant of 0.5 seconds. The time required per sample = 1.1 * NCYCLES + 2.7 seconds. The 1.1 seconds is total time per an acquisition cycle. NCYCLES is the number of acquisition cycles per sample. The 2.7 seconds is required for converting the measured values to temperature and storing average

in EEPROM. Root mean square (rms) temperature noise for a SBE 35 in a Triple Point of Water cell is typically expressed as $82 / \text{NCYCLES}^{1/2}$ in μK . In this cruise NCYCLES was set to 4 and the rms noise is estimated to be $0.04 \text{ m}^\circ\text{C}$.

When using the SBE 911 system with SBE 35, the deck unit receives incorrect signal from the under water unit for confirmation of firing bottle #16. In order to correct the signal, a module (Yoshi Ver. 1, EMS Co. Ltd., JAPAN) was used between the under water unit and the deck unit.

(4.6) Altimeter

The Benthos 2110 Series Altimeter (Benthos, Inc., USA) follows the basic principal of most echo ranging devices. That is, a burst of acoustic energy is transmitted and the time until the first reflection is received is determined. In this unit, a 400 microsecond pulse at 100 kHz is transmitted twice a second; concurrent with the transmission, a clock is turned off, thus the number of pulses out relates directly to the distance of the target from the unit. The internal ranging oscillator has an accuracy of approximately 5 % and is set assuring a speed of sound of 1,500 m/s. Thus the unit itself, neglecting variations in the speed of sound, can be considered accurate to 5 % or 0.1 meter, whichever is greater. The unit is rated to a depth of 12,000 meters.

The Benthos PSA-900 Programmable Sonar Altimeter (Benthos, Inc., USA) determines the distance of the target from the unit in almost the same way as the Benthos 2110. PSA-900 also uses the nominal speed of sound of 1,500 m/s. But, PSA-900 compensates for sound velocity errors due to temperature. In a PSA-900 operating at a 350 microsecond pulse at 200 kHz, the jitter of the detectors can be as small as 5 microseconds or approximately 0.4 centimeters total distance. Since the total travel time is divided by two, the jitter error is 0.25 centimeters. The PSA-900D is rated to a depth of 6,000 meters.

The following scale factors were used in SEASOFT:

PSA-900D, S/N 1026 and S/N 0396

$$\text{FSVolt} * 300 / \text{FSRange} = 10$$

$$\text{Offset} = 0.0$$

Model 2110-2, S/N 206

$$\text{FSVolt} * 300 / \text{FSRange} = 15$$

$$\text{Offset} = 0.0$$

(4.7) Fluorometer

The Seapoint Chlorophyll Fluorometer (Seapoint sensors, Inc., USA) is a high-performance, low power instrument to provide in-situ measurements of chlorophyll-a at depths up to 6,000 meters. The instrument uses modulated blue LED lamps and a blue excitation filter to excite chlorophyll-a. The fluorescent light emitted by the chlorophyll-a passes through a red emission filter and is detected by a silicon photodiode. The low level signal is then processed using synchronous demodulation circuitry, which generates an output voltage proportional to chlorophyll-a concentration.

The following coefficients were used in SEASOFT:

S/N 2148 (Leg 1)

$$\text{Gain} = 30$$

$$\text{Offset} = 0.0$$

S/N 2579 (Leg 4 and 5)

$$\text{Gain} = 30$$

$$\text{Offset} = 0.0$$

Chlorophyll-a concentration is computed as

$$\text{Chlorophyll-a } (\mu\text{g/l}) = (\text{Voltage} * 30 / \text{Gain}) + \text{Offset}$$

(5) Data collection and processing

(5.1) Data collection

CTD measurements were made using a SBE 9plus CTD equipped with two pumped temperature-conductivity (TC) sensors. The TC pairs were monitored to check drift and shifts by examining the

differences between the two pairs. Dissolved oxygen sensor was placed between the conductivity sensor module and the pump. Auxiliary sensors included Deep Ocean Standards Thermometer, altimeter and fluorometer. The SBE 9plus CTD (sampling rate of 24 Hz) was mounted horizontally in a 36-position carousel frame.

CTD system was powered on at least two minutes in advance of the operation and was powered off at least two minutes after the operation in order to acquire pressure data on ship's deck.

The package was lowered into the water from the starboard side and held 10 m beneath the surface for about one minute in order to activate the pump. After the pump was activated, the package was lifted to the surface and lowered at a rate of 0.5 m/s down to 100 m, where the package was stopped in order to operate the heave compensator of the crane. The package was lowered again at a rate of 1.2 m/s to the bottom. The position of the package relative to the bottom was monitored by the altimeter reading. Also the bottom depth was monitored by the SEABEAM multi-narrow beam sounder on board. For the up cast, the package was lifted at a rate of 1.2 m/s except for bottle firing stops. At each bottle firing stops, the bottle was fired after waiting 30 seconds and the package was stayed 7 seconds in order to sample temperature by the Deep Ocean Standards Thermometer. At 100 m from the surface, the package was stopped in order to stop the heave compensator of the crane.

Water samples were collected using a 36-bottle SBE 32 Carousel Water Sampler with 12-litre Niskin-X bottles. Before a cast for CFCs, the 36-bottle frame and Niskin-X bottles were wiped with acetone.

The SBE 11plus deck unit received the data signal from the CTD. Digitized data were forwarded to a personal computer running the SEASAVE data acquisition software. Temperature, conductivity, salinity, oxygen and descent rate profiles were displayed in real-time with the package depth and altimeter reading.

Data acquisition software (Leg 1, 2, 4 and 5)

SBE, Inc., SEASAVE-Win32, version 5.27b

After each CTD cast the SBE 35 data was retrieved using terminal software.

Terminal software (Leg 1, 2, 4 and 5)

SBE, Inc., SEATERM-Win32, version 1.33

(5.2) Data collection problems

Leg 1

At station P06_X11, a small fish was found in the primary TC-duct after the CTD cast and influenced on the primary salinity and oxygen data.

At station P06_166, communication between under water unit and deck unit broken at 1,800 m depth during the up cast, so the CTD cast was aborted. The system was checked after the cast and the fluorometer was found to be broken. Second cast was carried out at the site without fluorometer.

Frequently date and time of the SBE 35 (S/N 0022) did not change from "01 Jan 1980 00:00:-1" by the setup commands "ddmmyy" and "hhmmss". In such a case, test command (*rtctest) to reset date and time to default value (01 Jan 1980 00:00:00) did not work and date and time of the samples in the data file did not change from "01 Jan 1980 00:00:-1". This problem was found at stations P06_126, 125, 123, 122 and 121. It was found that the lithium backup battery had reached the end of its life expectancy by the post-cruise calibration (19 November 2003).

Leg 2

At station P06_127 second cast (first cast of this leg), frequent noise in primary temperature (its magnitude was about one to two °C) was found during 400 to 900 m depths in the down cast. So the cast was aborted and the CTD package was lifted to the deck. Primary temperature sensor was replaced from S/N 4216 to 1524 and the connection cable was also replaced. A third cast was done at the site. But similar noise in primary temperature was found at about 600 m depths in the down cast. So the cast was aborted. After replacing SBE 9plus from S/N 0575 to S/N 0357 and all of the connection cables used, a fourth cast was done at the site. After the cast primary temperature sensor was replaced again from S/N 1524 to 4216.

At station P06_X17, the personal computer, which displays and stores the serial data from the deck unit, was suddenly rebooted at about 1,500 m in the down cast. So the cast was aborted and the CTD package was lifted to the deck. Connection of the AC power cable was checked and an AC power supply, CVFT1-500H (TOKYO

SEIDEN Co., JAPAN), was used in order to remove voltage fluctuations and irregularities in power lines. A second cast was done at the site.

After station P06_102, Niskin-X bottle #9 (NX(NC)12021) was replaced with bottle #3 (NX(NC)12015) in order to check leakage or miss-trip of the bottle #9 that was guessed from analyzed values of salinity, oxygen and nutrients at station P06_114.

After station P06_101, a hook that was connecting top and bottom caps of Niskin-X bottle #9 by nylon line was away from the bottom cap. So the bottle #9 was replaced from NX(NC)12015 to NX(NC)12012 after the cast.

At station P06_061, output from secondary dissolved oxygen sensor (S/N 0069) showed unusual (negative) value. The secondary oxygen sensor was removed after the cast.

At the beginning of the down cast of station P06_044, the bottle confirmation signal correction module for SBE 35 continued to display unusual signal during the package was lifting from 10 m beneath the surface after activating the pump. The status lamp did not change from red to green though the module was turned on again. So the SEASAVE software was re-started from the surface in order to acquire the data in a new file, 044M02.

The SBE 35 (S/N 0022) backup battery problem was found at following stations: P06_119, 118, 117, 109, 108, X17, 106, 105, 104, 103, 102, 101, 100, 099, 098, 097, 096, 095, 094, 091, 089, 087, 086, 085, 084, 083, 082, 081, 080, 078, 077, 076, P06_069, 056, 055, 054, 053, 052, 050, 049, 045, 036, 031, 028, 027, 024, 023, 022, 021, 019, 016, 015, 014, 013, 012, 011, 010, 009, 008, 007, 006 and 005.

Leg 4

At stations A10_043 and 068, the same bottle was fired by mistake. Because the SEASAVE module didn't accept firing bottles more than 36 times, a bottle was fired using a fire button of the SBE 11plus deck unit in order to close all bottles. Bottles can be fired sequentially from its home position (#1) using the fire button of the SBE 11plus deck unit. Therefore the bottle #4 for the station A10_043 and #5 for the station A10_068 were closed by pushing the fire button of the deck unit 4 and 5 times, respectively.

At station A10_089, abnormal value (greater than 37 psu) in primary salinity was found between 60 and 100 m depths. Obtained data was carefully checked after the cast and unusual profiles in primary conductivity and primary temperature were seen. Therefore second cast was done at the site after the temperature, conductivity and oxygen sensors were washed with Triton X for 10 minutes.

When the SBE 35 (S/N 0045) data was uploaded by SEATERM, transmission error occurred at all casts except for A10_98, 99 and 100. Randomly dropped one character in the SBE 35 data file was estimated and the file was corrected manually.

Leg 5

At station I04_597, a small fish was found in primary TC-duct after the cast and influenced on the primary temperature, salinity and oxygen data shallower than 800 dbar of the up cast.

At station I03_529, the secondary conductivity sensor (S/N 1202) showed unusual value from 3,208 dbar of the up cast.

After station I03_551, a crack was found inside of the Niskin-X bottle #9 (NX(NC)12017) and the bottle was replaced to Niskin-X bottle (NX(NC)12021).

After station I03_513, carousel water sampler was replaced from S/N 0391 to S/N 0278.

At station I03_513 first cast, the scan number of the CTD data was not increased at 10 m beneath the surface. Therefore the SEASAVE software was re-started and the data was acquired from the surface in the same file, 513M01.

At station I03_511, the altimeter showed unusual values (negative). So the altimeter was replaced from S/N 1026 to S/N 0396.

At station I03_503, primary conductivity sensor (S/N 1088) showed unusual value from 4,995 dbar of the down cast. So the primary conductivity sensor was replaced to S/N 2435 after the cast.

At station I03_466, SEASAVE software was hung upped at about 120 m depths in the down cast. So the cast was aborted and the CTD package was lifted to the deck. The deck unit (SBE 11plus) was replaced from

S/N 0272 to S/N 0344 and SEASAVE software was re-started. The second cast was done at the site in a new file, 466M03.

When the SBE 35 (S/N 0045) data was uploaded by SEATERM, transmission error occurred at all casts except for I03_524 and 448. Randomly dropped one character in the SBE 35 data file was estimated and the file was corrected manually.

(5.3) Data processing

SEASOFT consists of modular menu driven routines for acquisition, display, processing, and archiving of oceanographic data acquired with SBE equipment, and is designed to work with a compatible personal computer. Raw data are acquired from instruments and are stored as unmodified data. The conversion module DATCNV uses the instrument configuration and calibration coefficients to create a converted engineering unit data file that is operated on by all SEASOFT post processing modules. Each SEASOFT module that modifies the converted data file adds proper information to the header of the converted file permitting tracking of how the various oceanographic parameters were obtained. The converted data is stored in rows and columns of ascii numbers. The last data column is a flag field used to mark scans as good or bad.

The following are the SEASOFT data processing module sequence and specifications used in the reduction of CTD data in this cruise.

Data processing software (Leg 1, 2, 4 and 5)

SBE, Inc., SEASOFT-Win32, version 5.27b

DATCNV converted the raw data to scan number, pressure, depth, temperatures, conductivities, oxygen voltage, descent rate, altitude and fluorescence. DATCNV also extracted bottle information where scans were marked with the bottle confirm bit during acquisition. The duration was set to 4.4 seconds, and the offset was set to 0.0 seconds.

ROSSUM created a summary of the bottle data. The bottle position, date, time were output as the first two

columns. Scan number, pressure, depth, temperatures, conductivities, oxygen voltage, descent rate, altitude and fluorescence were averaged over 4.4 seconds. And salinity, potential temperature, density (σ_θ) and oxygen were computed.

ALIGNCTD converted the time-sequence of conductivity and oxygen sensor outputs into the pressure sequence to ensure that all calculations were made using measurements from the same parcel of water. For a SBE 9plus CTD with the ducted temperature and conductivity sensors and a 3,000-rpm pump, the typical net advance of the conductivity relative to the temperature is 0.073 seconds. So, the SBE 11plus deck unit was set to advance the primary conductivity for 1.73 scans ($1.75/24 = 0.073$ seconds). As a result, the secondary conductivity was advanced 0.073 seconds relative to the temperature. Oxygen data are also systematically delayed with respect to depth mainly because of the long time constant of the oxygen sensor and of an additional delay from the transit time of water in the pumped plumbing line. This delay was compensated by 6 seconds advancing oxygen sensor output (oxygen voltage) relative to the temperature.

WILDEDIT marked extreme outliers in the data files. The first pass of WILDEDIT obtained an accurate estimate of the true standard deviation of the data. The data were read in blocks of 1000 scans. Data greater than 10 standard deviations were flagged. The second pass computed a standard deviation over the same 1000 scans excluding the flagged values. Values greater than 20 standard deviations were marked bad. This process was applied to all variables.

CELLTM used a recursive filter to remove conductivity cell thermal mass effects from the measured conductivity. Typical values used were thermal anomaly amplitude $\alpha = 0.03$ and the time constant $1/\beta = 7.0$.

FILTER performed a low pass filter on pressure with a time constant of 0.15 seconds. In order to produce zero phase lag (no time shift) the filter runs forward first then backwards.

WFILTER performed a median filter to remove spikes in the Fluorometer data. A median value was determined from a window of 49 scans.

SECTION selected a time span of data based on scan number in order to reduce a file size. The minimum number was set to be the start time when the CTD package was beneath the sea-surface after activation of the

pump. The maximum number was set to be the end time when the package came up from the surface. Data to check the CTD pressure drift were prepared before SECTION.

LOOPEDIT marked scans where the CTD was moving less than the minimum velocity of 0.0 m/s (traveling backwards due to ship roll).

DERIVE was used to compute oxygen.

BINAVG averaged the data into 1 dbar pressure bins. The center value of the first bin was set equal to the bin size. The bin minimum and maximum values are the center value plus and minus half the bin size. Scans with pressures greater than the minimum and less than or equal to the maximum were averaged. Scans were interpolated so that a data record exists every dbar.

DERIVE was re-used to compute salinity, potential temperature, and density (σ_θ).

SPLIT was used to split data into the down cast and the up cast.

(5.4) Additional data processing

After the data processing mentioned above the CTD data was carefully checked. Fine-tuning adjustments between the temperature measurement and the conductivity measurement to the default advance (0.073 seconds) were determined by looking for potential temperature – salinity plot as follows.

+ 0.031 seconds for P06_227, P06_192 (leg 1, secondary conductivity)

– 0.021 seconds for P06_081 (leg 2, primary conductivity)

– 0.042 seconds for A10 all stations (leg 4, primary conductivity)

– 0.030 seconds for I3/I4 all stations (leg 5, primary conductivity)

+ 0.045 seconds for I3/I4 all stations (leg 5, secondary conductivity)

For these stations the CTD data were re-processed with the additions following the data processing sequence mentioned above. Remaining spikes were removed by hand for the data file processed by LOOPEDIT and processed again following the data processing sequence after LOOPEDIT mentioned above.

(6) Post-cruise calibration

(6.1) Pressure

The CTD pressure sensor drift in the period of the cruise is estimated from the pressure readings on the ship deck. For best results the Paroscientific sensor has to be powered for at least 10 minutes before the operation and carefully temperature equilibrated. However, CTD system was powered only several minutes before the operation at most of stations. In order to get the calibration data for the pre- and post-cast pressure sensor drift, the CTD deck pressure is averaged over first and last two minutes, respectively. Then the atmospheric pressure deviation from a standard atmospheric pressure (14.7 psi) is subtracted from the CTD deck pressure. The atmospheric pressure was measured at the captain deck (20 m high from the base line) and sub-sampled one-minute interval for a meteorological data. Time series of the CTD deck pressure are shown in Figure 3.1.7 – 3.1.10.

The CTD pressure sensor drift is estimated from the deck pressure obtained above. Mean of the pre- and the post-casts data over the whole period for each leg gave an estimation of the pressure sensor drift from the pre-cruise calibration date at each leg. Mean residual pressure between the dead weight piston gauge and the calibrated CTD data at 0 dbar of the pre-cruise calibration is subtracted from the mean deck pressure. Offset of the pressure data is estimated to be within ± 0.4 dbar (Table 3.1.1). So the post-cruise calibration is not deemed necessary for the pressure sensors.

Table 3.1.1. Offset of the pressure data. Mean and standard deviation are calculated from time series of the average of the pre- and the post-cast deck pressures.

Leg	S/N	Mean deck pressure (dbar)	Standard deviation (dbar)	Residual pressure (dbar)	Estimated offset (dbar)
Leg 1	0575	0.52	0.11	0.12	0.40
Leg 2	0357	-0.71	0.10	-0.57	-0.14
Leg 4	0357	-0.84	0.18	-0.57	-0.27
Leg 5	0357	-0.92	0.17	-0.57	-0.35

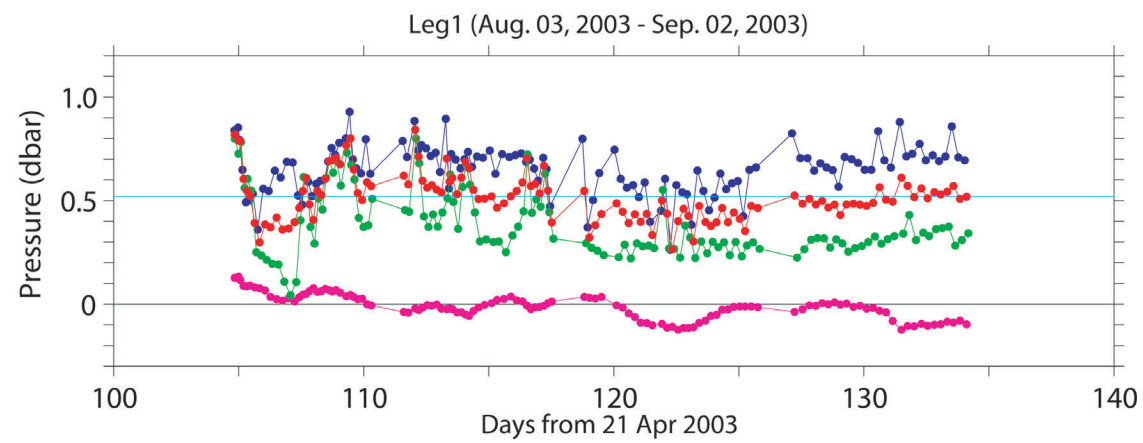

Figure 3.1.7. Time series of the CTD deck pressure for leg 1. Pink dot indicates atmospheric pressure anomaly. Blue and green dots indicate pre- and post-cast deck pressures, respectively. Red dot indicates an average of the pre- and the post-cast deck pressures.

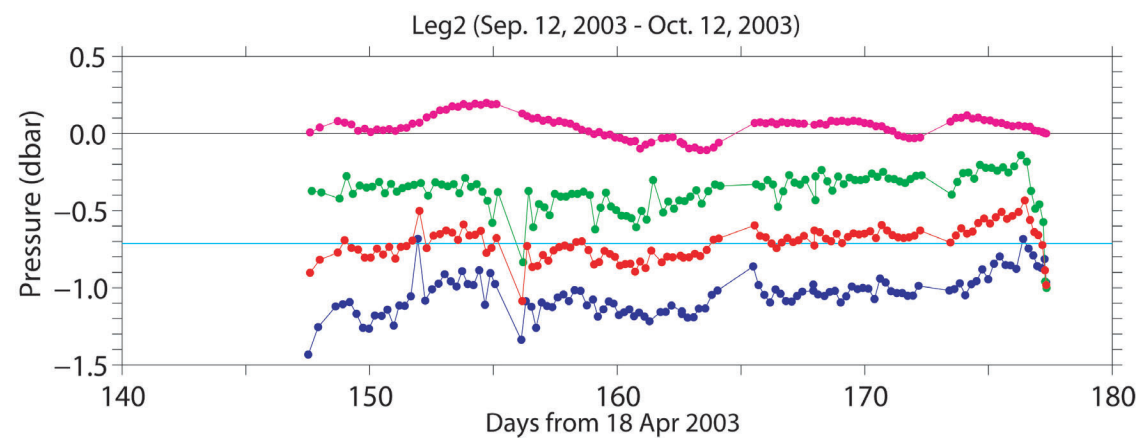

Figure 3.1.8. Same as Figure 3.1.7, but for leg 2.

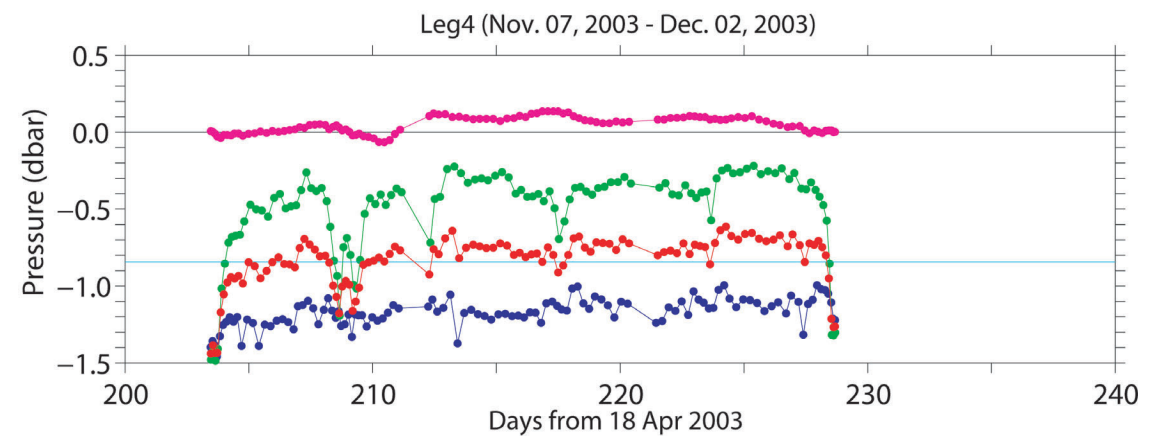

Figure 3.1.9. Same as Figure 3.1.7, but for leg 4.

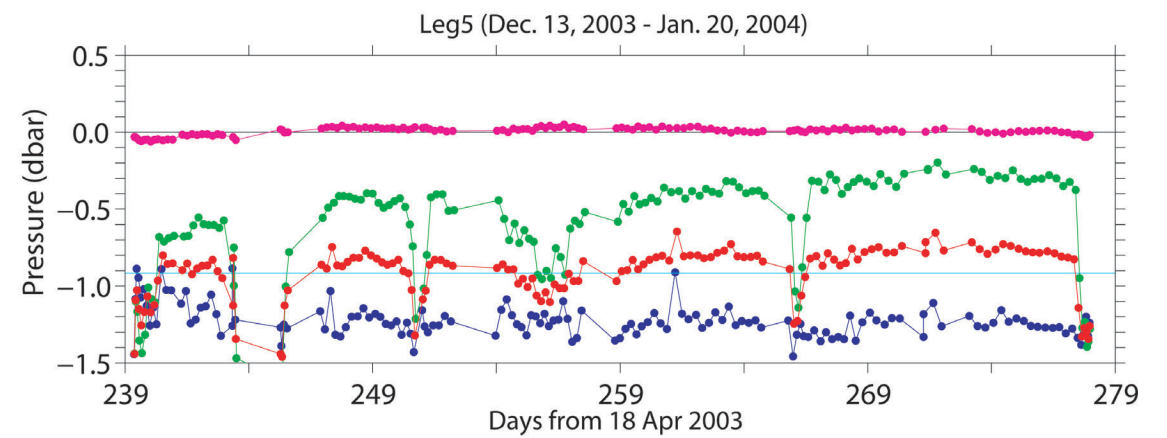

Figure 3.1.10. Same as Figure 3.1.7, but for leg 5.

(6.2) Temperature

The CTD temperature sensor (SBE 3) is made with a glass encased thermistor bead inside a needle. The needle protects the thermistor from seawater. If the thermistor bead is slightly large of specification, it receives mechanical stress when the needle is compressed at high pressure (Budeus and Schneider, 1998). The pressure sensitivity for a SBE 3 sensor is usually less than +2 mK / 6000 dbar. It is somewhat difficult to measure this effect in the laboratory and it is one of the primary reasons to use the SBE 35 at sea for critical work. Also SBE 3 measurements may be affected by viscous heating that occurs in a TC duct and does not occur for un-pumped SBE 35 measurements (Larson and Pederson, 1996). Furthermore the SBE 35 calibrations have some uncertainty (about 0.2 mK) and SBE 3 calibrations have some uncertainty (about 1 mK). So the practical corrections for CTD temperature data can be made by using a SBE 35, correcting the SBE 3 to agree with the SBE 35 (a linear pressure correction, a viscous heating correction and an offset for drift and/or calibration uncertainty).

Post-cruise sensor calibrations for the SBE 35 were performed at SBE, Inc., USA.

S/N 0022 (Leg 1 and 2), 19 November 2003 (2nd step: fixed point calibration)

Slope = 1.000018

Offset = 0.000116

S/N 0045 (Leg 4 and 5), 31 March 2004 (2nd step: fixed point calibration)

Slope = 1.000009

Offset = -0.000772

Offsets of the SBE 35 data from the pre-cruise calibration are estimated to be 0.0 (leg 1), 0.1 (leg 2), 0.1 (leg 4) and 0.2 (leg 5) m°C for temperature less than 4 °C. So the post-cruise calibration is not deemed necessary for the SBE 35 sensors.

The discrepancy between the CTD temperature and the standard thermometer (SBE 35) is considered to be a function of pressure and time. Since the pressure sensitivity is thought to be constant in time at least during observation period, the CTD temperature is calibrated as

$$\text{Calibrated temperature} = T - (c_0 * P + c_1 * t + c_2)$$

where T is CTD temperature in °C, P is pressure in dbar, t is time in days from pre-cruise calibration date of CTD temperature and c_0 , c_1 , and c_2 are calibration coefficients. The best fit sets of coefficients are determined by minimizing the sum of absolute deviation from the SBE 35 data. The MATLAB® function FMINSEARCH is used to determine the sets. The FMINSEARCH uses the simplex search method (Lagarias et al., 1998). This is a direct search method that does not use numerical or analytic gradients.

The calibration is performed for the following temperature data.

Leg 1: secondary (S/N 1464)

Leg 2: primary (S/N 1254) for P06_127

primary (S/N 4216) from P06_125 to P06_004

Leg 4: primary (S/N 1464)

Leg 5: primary (S/N 1464) except for I04_597 and I03_503

secondary (S/N 4323) for I04_597 and I03_503

The CTD data created by the software module ROSSUM are used. The deviation of CTD temperature from the SBE 35 at depth shallower than 2,000 dbar is large for determining the coefficients with sufficient accuracy since the vertical temperature gradient is strong in the regions. So the coefficients are determined using the data in the depth deeper than 1,950 dbar.

Since pressure sensitivity for the secondary temperature sensor (S/N 1464) is small compared with that of the primary temperature sensor (S/N 4188) in leg 1, data from the secondary temperature sensor are used in leg 1. Since the secondary temperature sensor (S/N 2453) had unusually large pressure sensitivity (+ 5m°C / 6,000 dbar) in leg 2, data from the primary temperature sensor (S/N 1254 and S/N 4216) are used in leg 2 although the primary temperature sensor (S/N 4216) reading showed unusually large time drift (an order of 1 m°C / month). Since the difference between primary temperature (S/N 4216) and SBE 35 data showed different tendency of the time drift during leg 2, the data was divided four periods and the coefficients are determined for each period with fixed pressure sensitivity (c_0 is constant). For station I04_597 and I03_503 in leg 5, data quality of the primary

conductivity sensor were bad, so the secondary temperature sensor is also calibrated and the data from the secondary temperature sensor are used for the two stations in leg 5.

The number of data used for the calibration and the mean absolute deviation from the SBE 35 are listed in Table 3.1.2 and the calibration coefficients are listed in Table 3.1.3. The results of the post-cruise calibration for the CTD temperature are summarized in Table 3.1.4 and shown in Figure 3.1.11 to Figure 3.1.14.

Table 3.1.2. Number of data used for the calibration (pressure > 1,950 dbar) and mean absolute deviation (ADEV) between the CTD temperature and the SBE 35.

Leg	S/N	Number of data	ADEV (m°C)	Note
Leg 1	1464	1724	0.15	
Leg 2	1254	16	0.10	only P06_127
	4216	1108	0.11	
Leg 4	1464	1136	0.17	
Leg 5	1464	1659	0.14	
	4323	1659	0.18	

Table 3.1.3. Calibration coefficients for the CTD temperature sensor

Leg	S/N	c ₀ (°C/dbar)	c ₁ (°C/day)	c ₂ (°C)	Note
Leg 1	1464	-8.26735877e-008	1.48131e-005	0.37e-3	
Leg 2	1254	2.65640509e-007	-	-0.68e-3	P06_127
	4216	-5.25359666e-008	1.09403e-004	-3.18e-3	P06_125 – P06_094
		-5.25359666e-008	-2.08090e-005	4.01e-3	P06_093 – P06_055
		-5.25359666e-008	-3.24966e-005	5.12e-3	P06_054 – P06_024
		-5.25359666e-008	3.14971e-005	0.79e-3	P06_023 – P06_004
Leg 4	1464	-7.07002361e-008	9.73776e-006	-0.03e-3	
Leg 5	1464	-6.97861330e-008	-1.26196e-006	0.83e-3	
	4323	2.51539456e-007	-1.65317e-005	0.95e-3	I04_597, I03_503

Table 3.1.4. Difference between the CTD temperature and the SBE 35 after the post-cruise calibration. Mean and standard deviation (Sdev) are calculated below and above 2,000 dbar for each leg. Number of data used is also shown.

Leg	Pressure >= 2,000 dbar			Pressure < 2,000 dbar		
	Num	Mean (m°C)	Sdev (m°C)	Num	Mean (m°C)	Sdev (m°C)
Leg 1	1687	0.01	0.21	2660	-0.26	2.74
Leg 2	1087	0.00	0.18	3027	0.20	3.75
Leg 4	1113	0.01	0.33	2795	-0.01	4.64
Leg 5	1624	0.00	0.22	3140	0.27	6.61

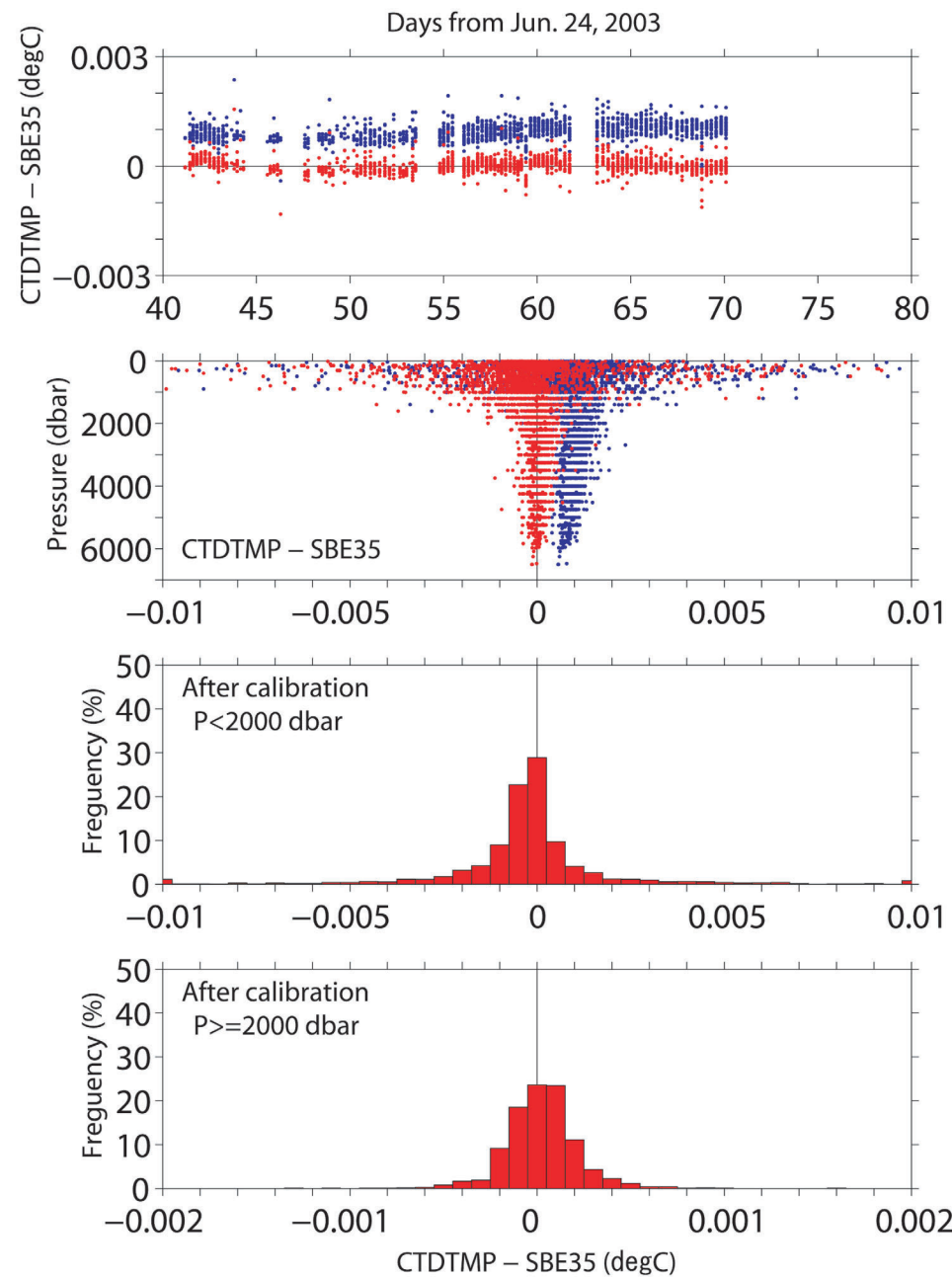

Figure 3.1.11. Difference between the CTD temperature and the Deep Ocean Standards thermometer (SBE 35) for leg 1. Blue and red dots indicate before and after the post-cruise calibration using the SBE 35 data, respectively. Lower two panels show histogram of the difference after the calibration.

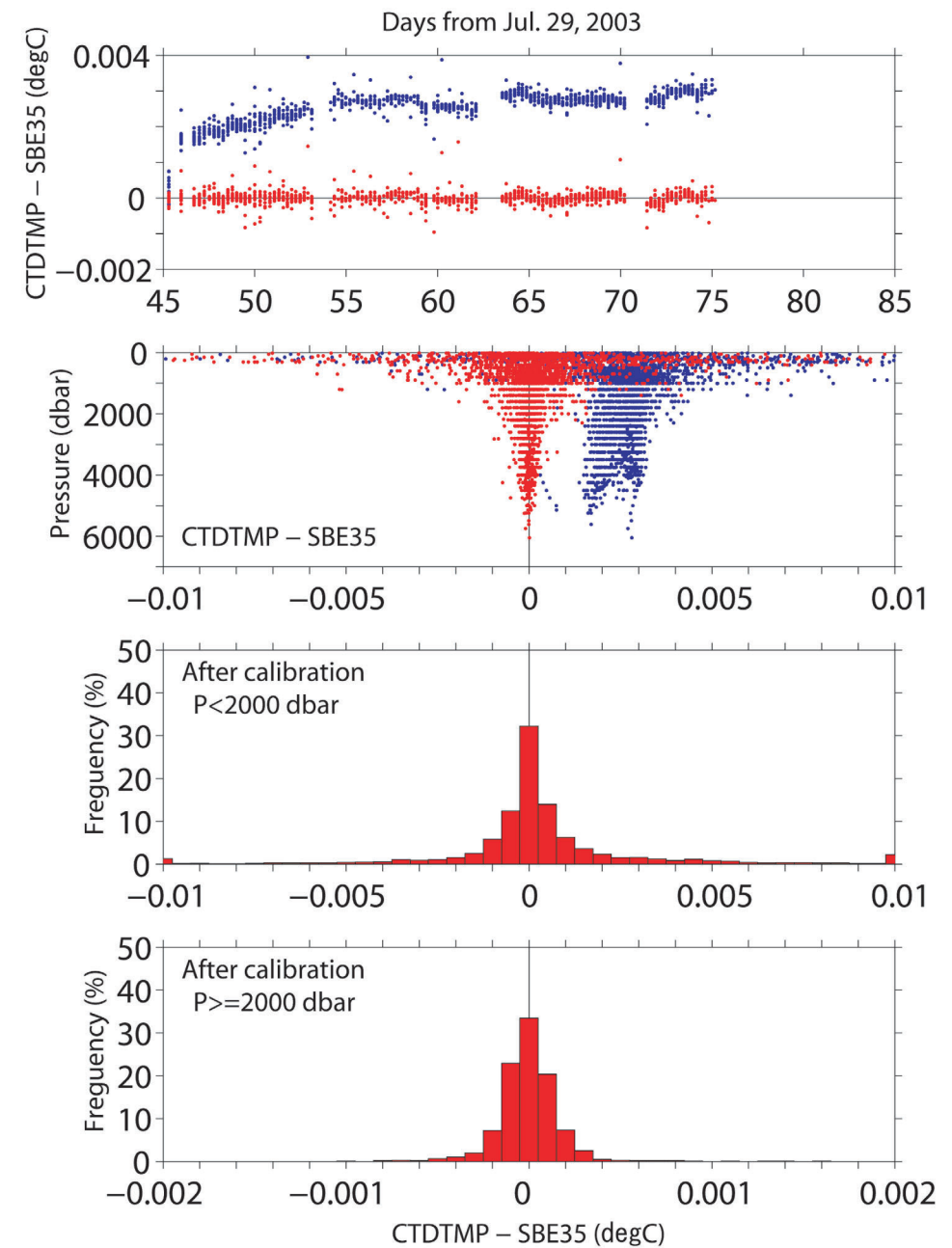

Figure 3.1.12. Same as Figure 3.1.11, but for leg 2.

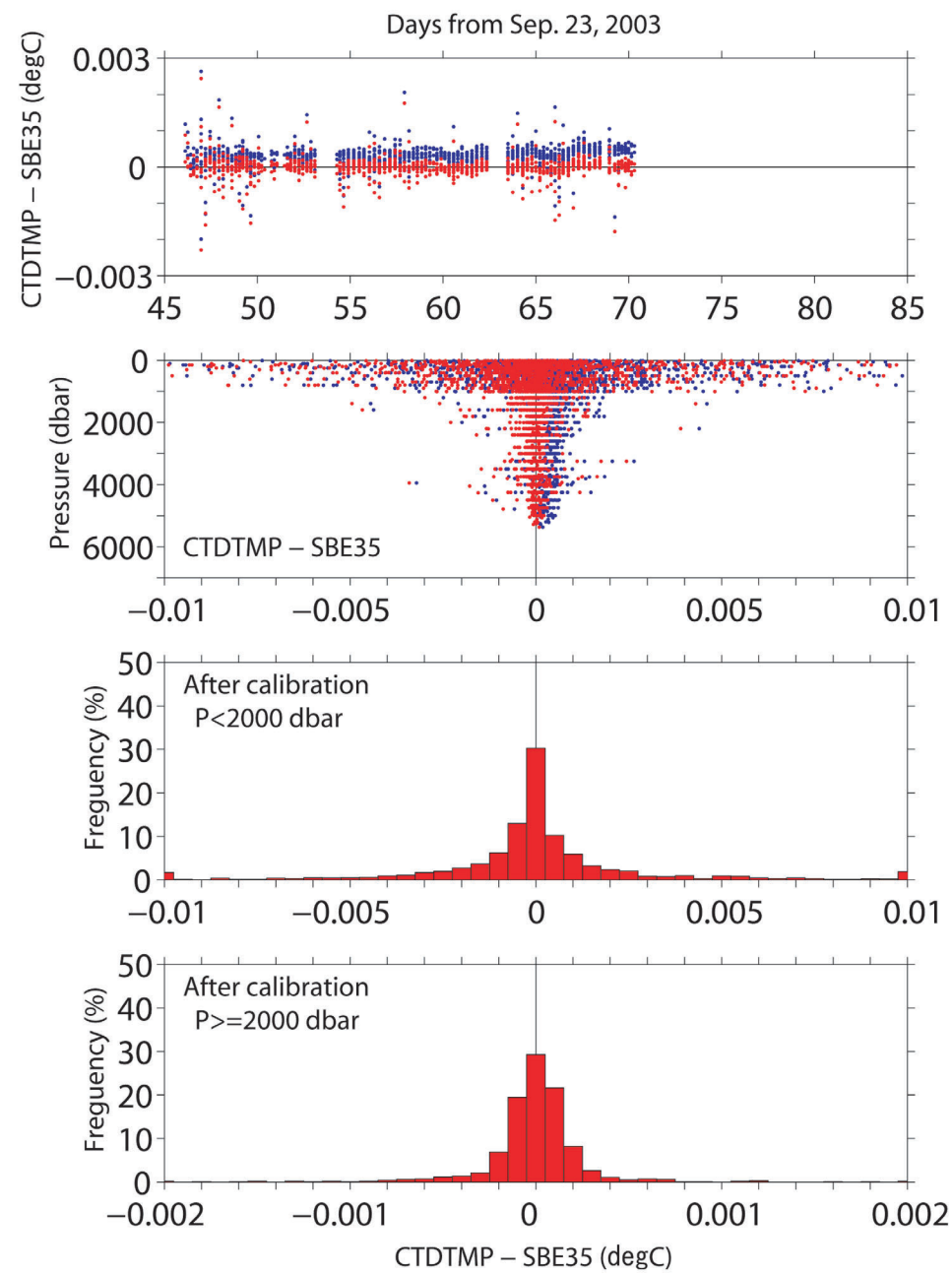

Figure 3.1.13. Same as Figure 3.1.11, but for leg 4.

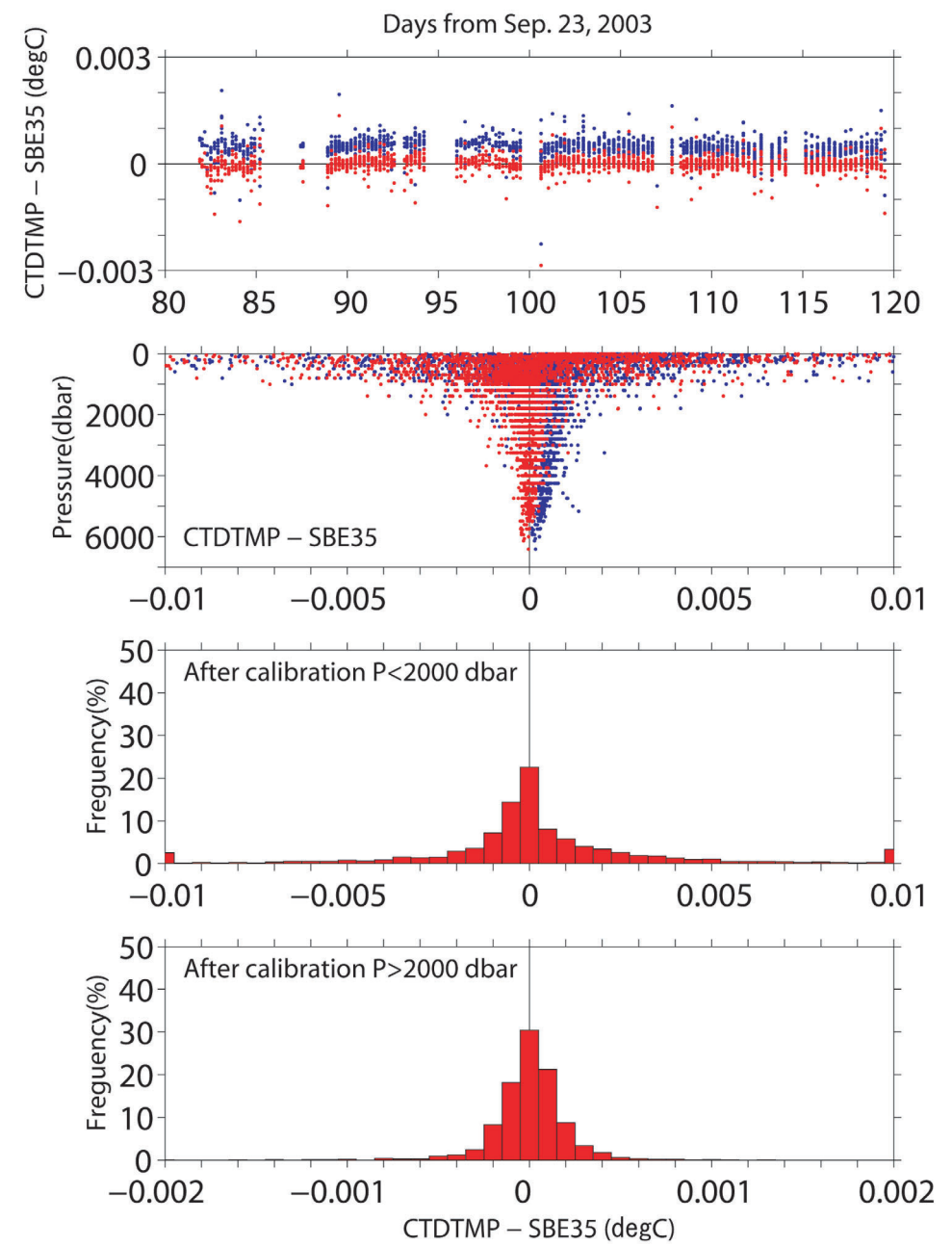

Figure 3.1.14. Same as Figure 3.1.11, but for leg 5.

(6.3) Salinity

The discrepancy between the CTD salinity and the bottle salinity is considered to be a function of conductivity and pressure. The CTD salinity is calibrated as

$$\text{Calibrated salinity} = S - (c_0 * P + c_1 * C + c_2 * C * P + c_3)$$

where S is CTD salinity, P is pressure in dbar, C is conductivity in S/m and c_0 , c_1 , c_2 and c_3 are calibration coefficients. The best fit sets of coefficients are determined by minimizing the sum of absolute deviation with a weight from the bottle salinity data. The MATLAB[®] function FMINSEARCH is used to determine the sets. The weight is given as a function of vertical salinity gradient and pressure as

$$\text{Weight} = \min[4, \exp\{\log(4) * \text{Gr} / \text{Grad}\}] * \min[4, \exp\{\log(4) * P^2 / \text{PR}^2\}]$$

where Grad is vertical salinity gradient in PSU dbar⁻¹, P is pressure in dbar. Gr and PR are threshold of the salinity gradient (default value is 0.5 mPSU dbar⁻¹) and pressure (1,000 dbar), respectively. When salinity gradient is small (large) and pressure is large (small), the weight is large (small) at maximum (minimum) value of 16 (1). The salinity gradient is calculated using up-cast CTD salinity data. The up-cast CTD salinity data is low-pass filtered with a 3-point (weights are 1/4, 1/2, 1/4) triangle filter before the calculation.

The calibration is performed for the salinity derived from the following conductivity sensor.

Leg 1: secondary (S/N 1202)

Leg 2: primary (S/N 2240)

Leg 4: primary (S/N 1203)

Leg 5: primary (S/N 1088) from I04_610 to I03_504 except for I04_597

secondary (S/N 1202) for I04_597 and I03_503

primary (S/N 2435) from I03_502 to I03_444

The CTD data created by the software module ROSSUM are used after the post-cruise calibration for the CTD temperature. For station I04_597 and I03_503 in leg 5, data quality of the primary conductivity sensor were bad, so the data from the secondary conductivity sensor are used for the two stations in leg 5.

The coefficients are basically determined for each station. Some stations, especially for shallow stations, are

grouped for determining the calibration coefficients. In order to obtain better result, the threshold of the salinity gradient is changed to 0.3 mPSU/dbar for P06_206, P06_205, P06_056, I03_554, I03_518, I03_517, I03_506, I03_500, I03_490, I03_488, I03_480, I03_X09 and changed to 0.2 mPSU/dbar for I04_604, I04_588, I03_562, I03_561, I03_560, I03_599, I03_557, I03_556, I03_555. An example of the calibration is shown in Figure 3.1.15.

The results of the post-cruise calibration for the CTD salinity are summarized in Table 3.1.5 and shown in Figure 3.1.16 to Figure 3.1.19. And the calibration coefficients, the mean absolute deviation (ADEV) from the bottle salinity and the number of the data (NUM) used for the calibration are listed in Table 3.1.6 to Table 3.1.9.

Table 3.1.5. Difference between the CTD salinity and the bottle salinity after the post-cruise calibration. Mean and standard deviation (Sdev) are calculated below and above 1,000 dbar for each leg. Number of data used is also shown.

Leg	Pressure >= 1,000 dbar			Pressure < 1,000 dbar		
	Num	Mean (mPSU)	Sdev (mPSU)	Num	Mean (mPSU)	Sdev (mPSU)
Leg 1	1789	-0.01	0.34	1579	-0.24	1.25
Leg 2	1612	0.04	0.33	1427	-0.27	1.44
Leg 4	1433	-0.02	0.55	1336	-0.10	1.90
Leg 5	2070	-0.01	0.57	1822	0.42	4.46

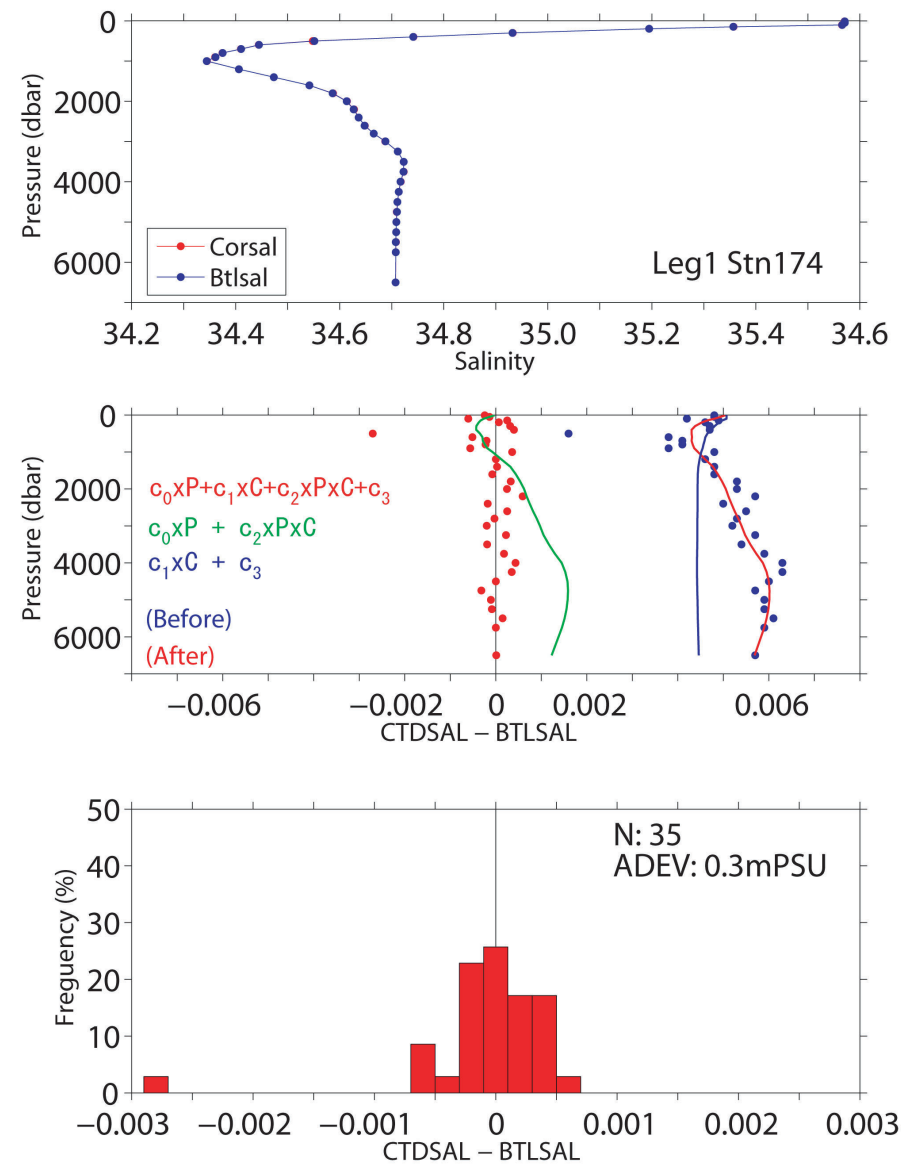

Figure 3.1.15. An example of difference between the CTD salinity and the bottle salinity (leg 1, P06_174).

Upper panel shows vertical profile of bottle salinity (blue) and calibrated CTD salinity (red). Middle panel shows vertical distribution of the difference (blue dot: before the calibration, red dot: after the calibration).

Lower panel shows histogram of the difference after the calibration.

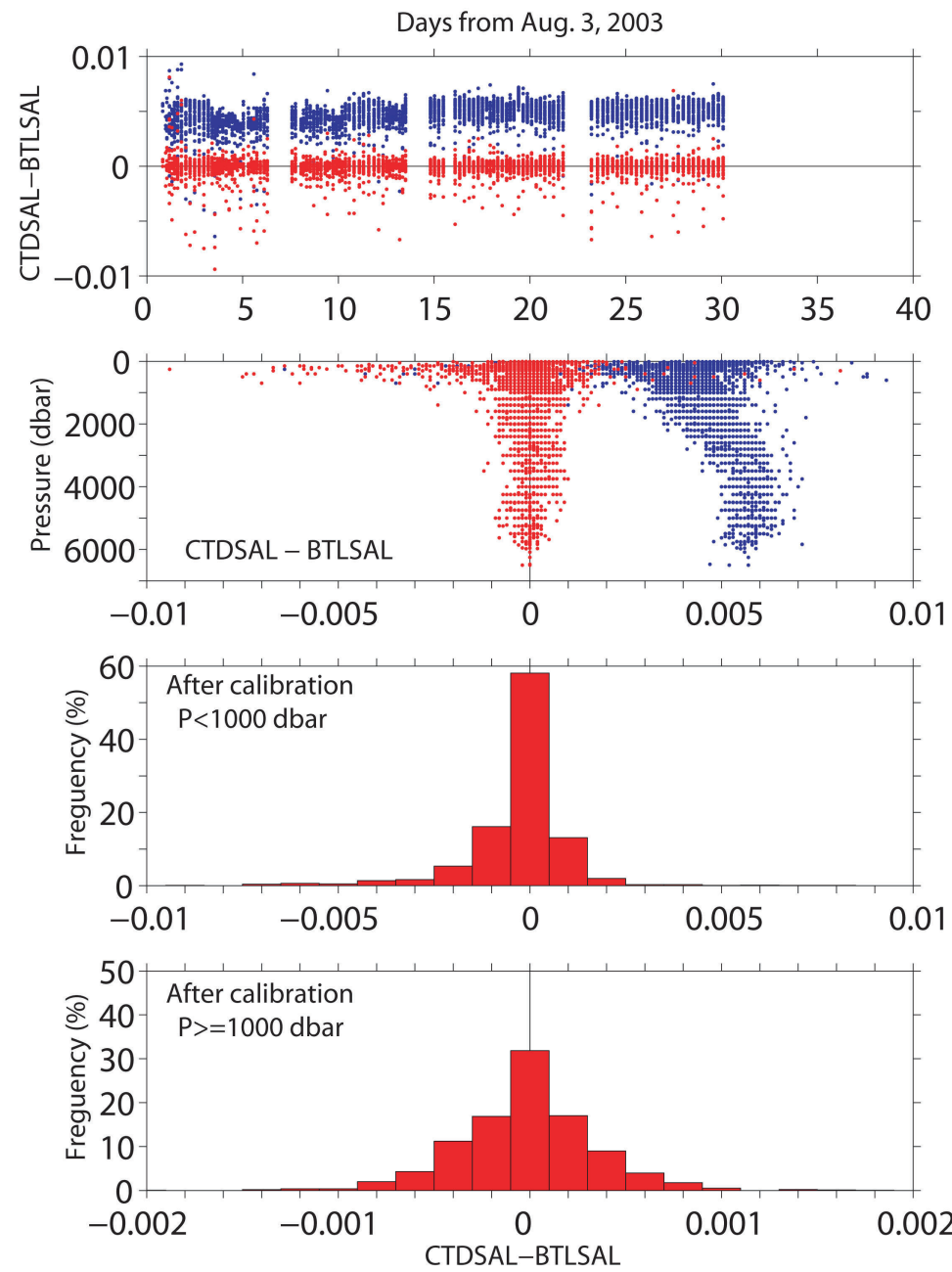

Figure 3.1.16. Difference between the CTD salinity and the bottle salinity for leg 1. Blue and red dots indicate before and after the post-cruise calibration using the bottle salinity data, respectively. Lower two panels show histogram of the difference after the calibration.

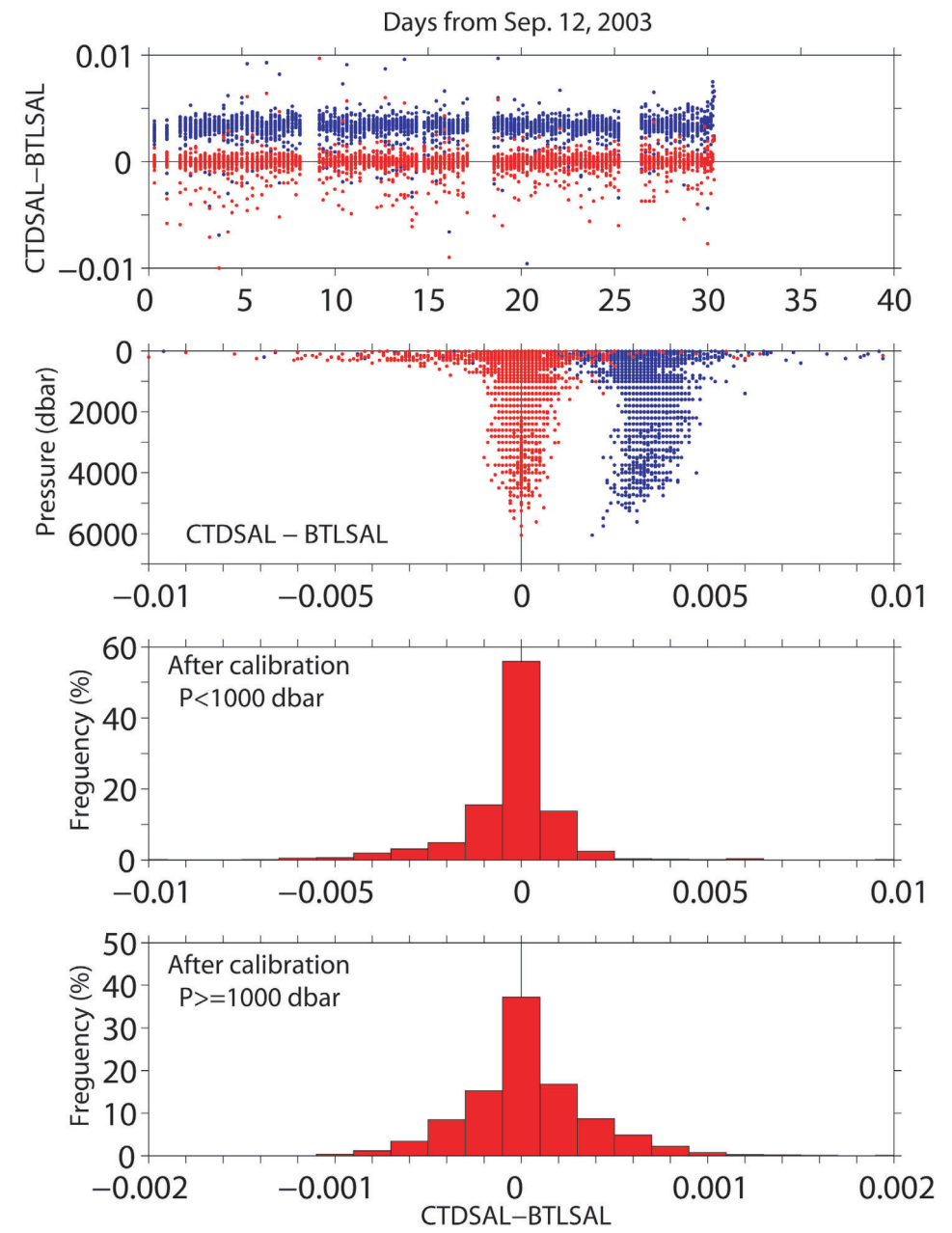

Figure 3.1.17. Same as Figure 3.1.16, but for leg 2.

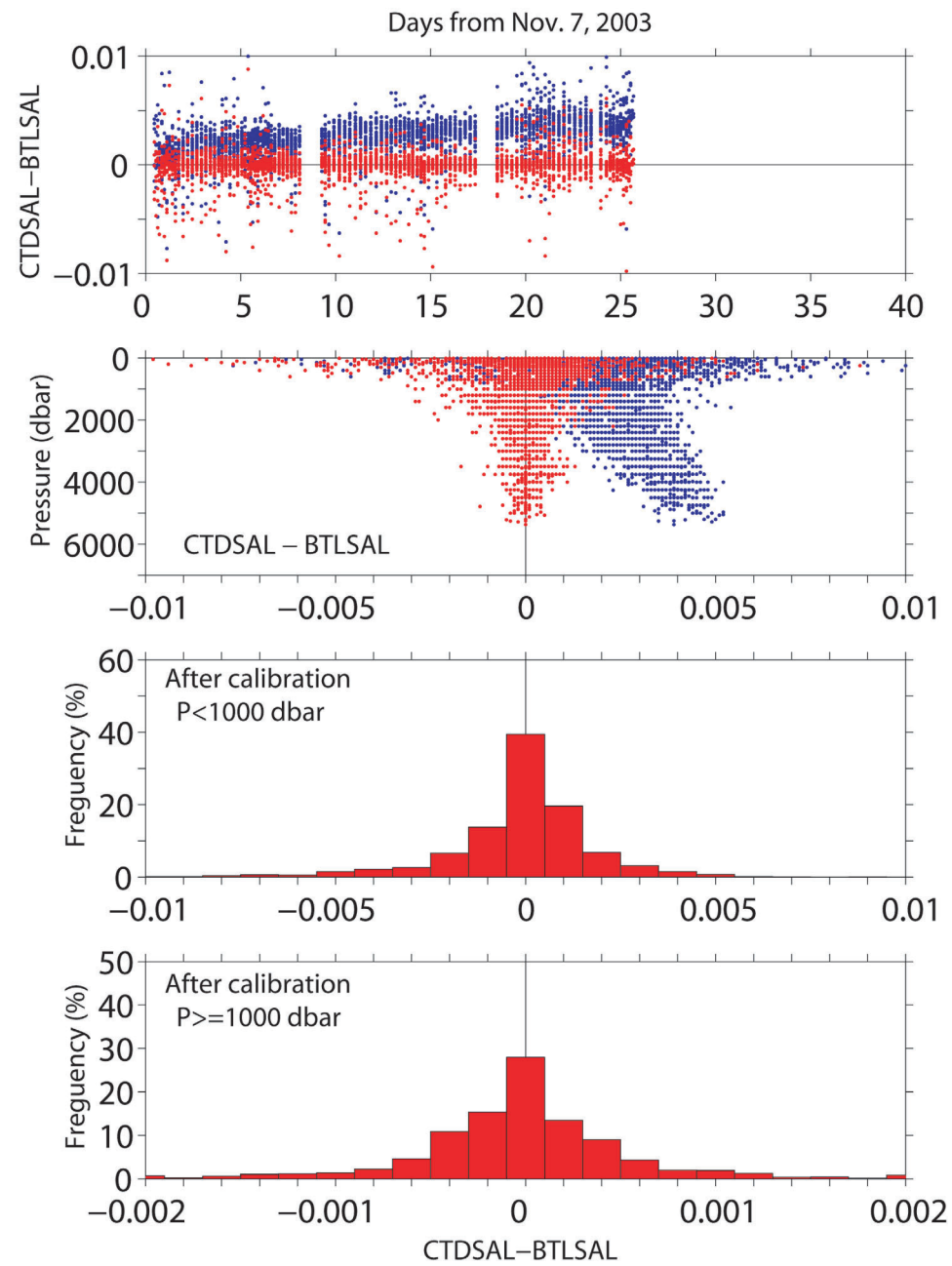

Figure 3.1.18. Same as Figure 3.1.16, but for leg 4.

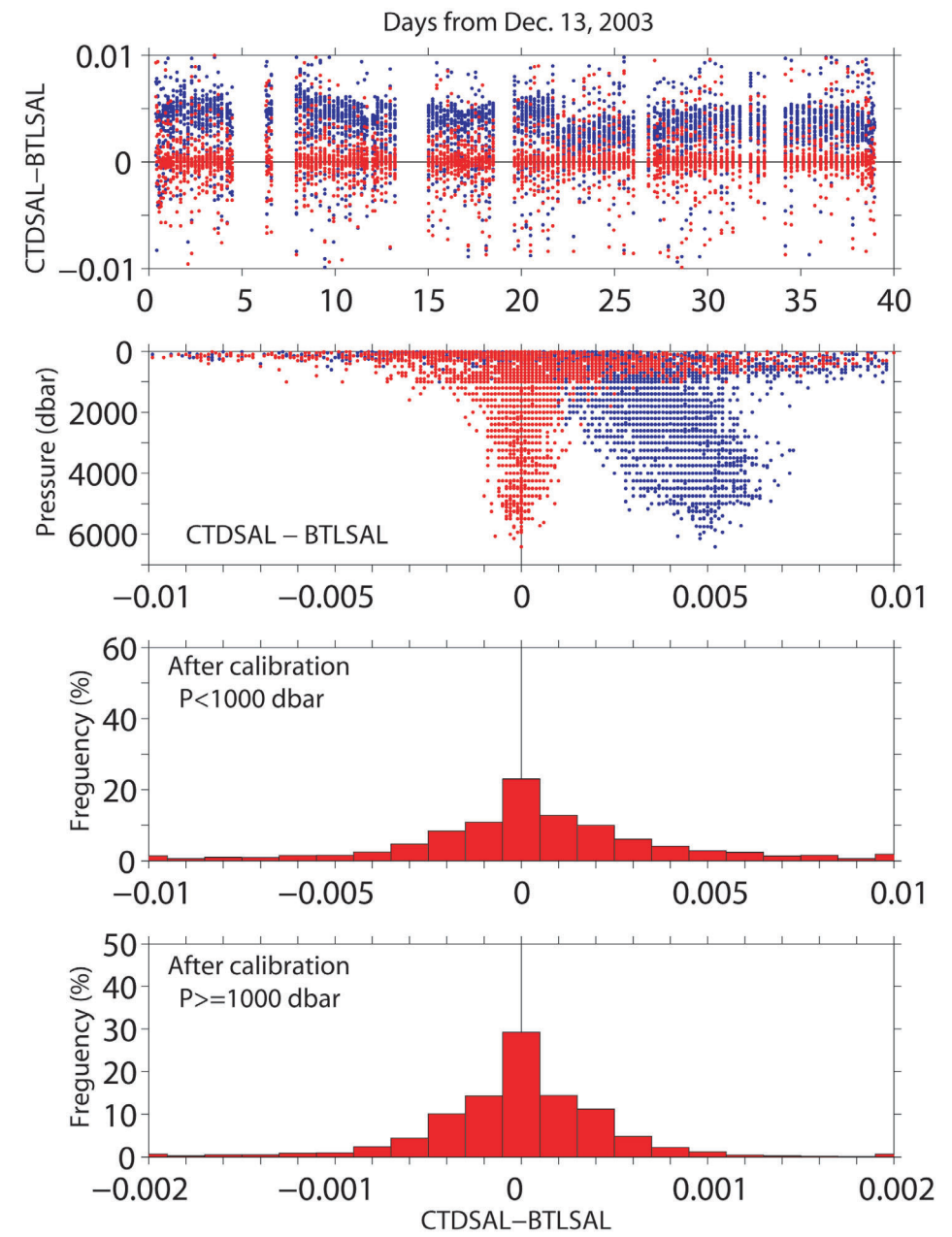

Figure 3.1.19. Same as Figure 3.1.16, but for leg 5.

Table 3.1.6. Calibration coefficients of CTD salinity for leg 1.

STN	CAST	C0	C1	C2	C3	ADEV	NUM	STN	CAST	C0	C1	C2	C3	ADEV	NUM
246	1	-8.44921852e-004	-2.85322312e-003	1.81725396e-004	1.803606e-002	0.0006	7	164	1	7.16036872e-006	3.52755766e-004	-2.19101704e-006	3.675030e-003	0.0004	36
245	1	(grouped with 246_1)						163	1	5.93241947e-006	6.19063038e-004	-1.79279380e-006	2.661226e-003	0.0003	35
244	1	-1.47654312e-005	1.11424343e-003	5.44875346e-006	-3.051446e-003	0.0004	15	162	1	4.61148087e-006	1.14754591e-003	-1.32940870e-006	2.435759e-004	0.0003	30
243	1	-1.79330975e-005	8.46786425e-004	6.20987575e-006	-2.352588e-003	0.0017	20	161	1	4.89394898e-006	3.14059500e-004	-1.47204459e-006	3.631388e-003	0.0003	32
242	1	-1.20142899e-005	3.04629234e-005	4.00144337e-006	2.260560e-003	0.0012	17	160	1	1.04735892e-005	4.09791272e-004	-3.25235473e-006	3.589668e-003	0.0003	34
241	1	-2.25460230e-005	7.90014896e-004	7.65734005e-006	-1.883926e-003	0.0006	23	159	1	7.79802795e-006	3.64777958e-004	-2.38263486e-006	4.707916e-003	0.0004	33
240	1	-3.35783607e-006	-3.49316637e-004	1.25325739e-006	4.565917e-003	0.0008	29	158	1	7.76758181e-006	1.22943137e-003	-2.41217442e-006	8.789758e-004	0.0004	35
239	1	1.87397745e-006	-5.71412527e-005	-3.92860256e-007	3.322891e-003	0.0008	59	X15	1	8.43044661e-006	1.68680708e-003	-2.54792303e-006	-1.179840e-003	0.0003	35
238	1	(grouped with 239_1)						156	1	9.51594534e-006	8.13382424e-005	-2.98835981e-006	4.898382e-003	0.0003	34
237	1	2.64161321e-006	3.52397720e-005	-7.19020107e-007	3.966363e-003	0.0006	31	155	1	6.25805827e-006	1.02407590e-003	-1.86689109e-006	8.142096e-004	0.0003	33
X11	1	7.30912244e-006	-2.53152179e-005	-2.19970046e-006	4.315417e-003	0.0006	31	154	1	1.31895787e-005	1.01724270e-003	-4.09766594e-006	1.556987e-003	0.0004	34
235	1	5.84202460e-006	3.87539699e-004	-1.72260317e-006	2.607640e-003	0.0007	53	153	1	5.61720560e-006	5.55948486e-004	-1.66118623e-006	2.146719e-003	0.0005	34
234	1	(grouped with 235_1)						152	1	6.73934693e-006	7.53233905e-004	-2.06317085e-006	2.075086e-003	0.0003	35
232	1	8.70486638e-006	6.37993089e-004	-2.60151800e-006	1.543716e-003	0.0003	31	151	1	1.12644256e-005	2.68759087e-004	-3.50182361e-006	3.779136e-003	0.0004	34
231	1	6.11016031e-006	-3.72985934e-004	-1.97669852e-006	5.943458e-003	0.0004	25	150	1	4.36485623e-007	1.33518007e-004	-3.57097825e-008	3.859029e-003	0.0003	32
230	1	2.96737331e-006	-7.64139173e-004	-9.84921598e-007	6.996191e-003	0.0014	19	149	1	7.15101838e-006	-8.37715293e-004	-2.19317263e-006	7.674617e-003	0.0005	34
229	1	1.26996147e-006	3.28470606e-005	-1.34484981e-007	3.177876e-003	0.0004	20	148	1	9.04790218e-006	-2.47945695e-004	-2.81743284e-006	5.725332e-003	0.0008	70
228	1	7.89709461e-006	6.39901918e-005	-2.42633393e-006	4.087286e-003	0.0004	23	147	1	(grouped with 148_1)					
227	1	8.65204446e-006	-1.52417874e-004	-2.70309984e-006	4.493966e-003	0.0005	23	146	1	1.07713646e-005	3.06075602e-004	-3.32942549e-006	3.584444e-003	0.0004	35
226	1	-1.07097512e-005	3.92906474e-005	3.71731142e-006	2.065750e-003	0.0005	19	145	1	4.76273039e-006	-1.99446420e-004	-1.44535436e-006	5.500238e-003	0.0003	33
225	1	-2.20553882e-006	2.37242621e-005	8.08133270e-007	3.727567e-003	0.0005	19	144	1	5.03127166e-006	6.47469365e-004	-1.51891835e-006	2.384802e-003	0.0003	34
224	1	6.15823612e-007	-8.51015027e-004	-3.93290815e-007	7.805595e-003	0.0005	35	143	1	7.73139705e-006	4.81401641e-004	-2.33450864e-006	2.859026e-003	0.0004	32
223	1	(grouped with 224_1)						142	1	3.25671257e-006	3.48568251e-004	-8.91398066e-007	2.631821e-003	0.0003	34
222	1	-8.99080114e-007	4.61002001e-004	4.12410329e-007	1.347728e-003	0.0004	16	140	1	7.32182800e-006	-3.49420748e-004	-2.27004404e-006	6.323928e-003	0.0003	34
221	1	1.27055039e-005	-5.14927796e-004	-4.10890266e-006	6.499679e-003	0.0009	15	139	1	8.77662364e-006	9.75436246e-004	-2.67023956e-006	1.014160e-003	0.0003	33
220	1	1.24780052e-005	-1.02552600e-003	-4.36665341e-006	9.753479e-003	0.0005	31	138	1	9.79491837e-006	-6.51408320e-006	-3.04294828e-006	5.342095e-003	0.0003	33
219	1	(grouped with 220_1)						137	1	6.28053857e-006	6.37077901e-004	-1.87505136e-006	2.056861e-003	0.0004	35
218	1	1.01570889e-005	-1.53666287e-003	-3.65050307e-006	1.134517e-002	0.0005	16	136	1	4.66363859e-006	-1.24081499e-004	-1.37841981e-006	4.828283e-003	0.0004	34
217	1	3.86843912e-006	-3.62020053e-004	-1.30369207e-006	5.937949e-003	0.0009	20	135	1	6.06439832e-006	5.14468918e-004	-1.84274970e-006	2.800154e-003	0.0004	35
216	1	4.16830514e-006	-4.74682430e-004	-1.18058902e-006	5.237779e-003	0.0008	26	134	1	-2.46184900e-007	8.40833961e-004	2.22207117e-007	1.073010e-003	0.0004	33
215	1	-1.34263454e-006	3.27945081e-004	6.33548548e-007	2.046815e-003	0.0003	27	133	1	5.07778139e-006	5.66576138e-004	-1.48740825e-006	2.435355e-003	0.0004	33
214	1	-5.56460950e-007	-5.89527539e-005	4.17718601e-007	3.494895e-003	0.0007	26	132	1	2.45673475e-006	2.57294721e-004	-6.71430885e-007	3.537284e-003	0.0003	31
213	1	5.67612683e-006	1.83933823e-004	-1.73643769e-006	3.955490e-003	0.0008	22	131	1	8.67642085e-006	6.82928641e-004	-2.64135510e-006	2.438083e-003	0.0006	33
212	1	-7.03287620e-007	-3.12265776e-005	3.90167326e-007	3.811262e-003	0.0005	47	130	1	3.09855870e-006	5.52698196e-004	-8.56241860e-007	2.273537e-003	0.0007	28
211	1	(grouped with 212_1)						129	1	3.10945947e-006	6.19295127e-004	-8.78810341e-007	2.299027e-003	0.0003	34
210	1	6.70476379e-007	-1.69865867e-004	-4.41131503e-007	5.114473e-003	0.0004	29	X16	1	8.55322212e-006	1.02077904e-003	-2.58183277e-006	1.068700e-003	0.0003	33
209	1	(grouped with 210_1)						127	1	1.74214746e-006	1.08857352e-003	-3.75360023e-007	1.630400e-004	0.0005	33
208	1	6.00448142e-006	5.53934416e-004	-1.69982380e-006	1.802479e-003	0.0004	50	126	1	6.49071488e-006	-1.46894634e-006	-1.95334308e-006	4.316887e-003	0.0004	32
207	1	(grouped with 208_1)						125	1	9.12138422e-006	-1.79016143e-005	-2.81375058e-006	4.923972e-003	0.0005	30
206	1	4.64729710e-006	5.51338341e-004	-1.32887650e-006	1.887632e-003	0.0005	23	124	1	5.83734046e-006	1.04547347e-003	-1.74636309e-006	1.005527e-003	0.0003	31
205	1	4.46584551e-006	2.41688748e-004	-1.24654155e-006	3.010707e-003	0.0005	25	123	1	7.08998739e-006	7.14488226e-004	-2.12736420e-006	2.325255e-003	0.0004	34
204	1	1.11735252e-005	-5.90853683e-004	-3.71856012e-006	8.006403e-003	0.0004	23	122	1	1.07192523e-005	8.84941221e-004	-3.25804652e-006	1.390653e-003	0.0004	32
203	1	8.92220866e-006	-4.45411947e-005	-2.87789296e-006	5.234556e-003	0.0008	27	121	1	1.20942395e-005	7.84158040e-004	-3.69298708e-006	1.855098e-003	0.0006	33
202	1	(grouped with 203_1)													
201	1	2.29414210e-006	1.79889353e-004	-7.03472865e-007	3.764313e-003	0.0002	20								
200	1	1.32837969e-005	1.65883247e-004	-4.12477547e-006	3.724246e-003	0.0004	23								
199	1	1.61941924e-005	-6.44720860e-004	-5.36094718e-006	7.715184e-003	0.0003	21								
198	1	6.63995463e-006	4.91363693e-006	-1.91723854e-006	3.827215e-003	0.0006	15								
197	1	1.66161967e-006	3.40098144e-004	-3.67081829e-007	2.530356e-003	0.0003	21								
196	1	-3.40672772e-007	-5.45591857e-005	2.40743442e-007	4.329603e-003	0.0005	26								
195	1	4.85126884e-006	3.23742436e-004	-1.39681428e-006	3.215058e-003	0.0005	28								
194	1	-5.91621548e-007	4.13475021e-004	3.48093238e-007	2.281777e-003	0.0006	29								
X14	1	4.36130896e-006	4.87129753e-004	-1.19534662e-006	2.203125e-003	0.0004	29								
192	1	4.73715417e-006	-5.05407481e-005	-1.40783772e-006	4.868068e-003	0.0005	30								
191	1	5.66689933e-006	1.04193655e-003	-1.58098979e-006	6.440119e-005	0.0005	30								
190	1	4.58971446e-006	6.87439418e-004	-1.24081105e-006	1.241718e-003	0.0005	29								
186	1	1.77554072e-006	3.57225378e-004	-4.08899732e-007	2.904227e-003	0.0005	52								
185	1	(grouped with 186_1)													
184	1	6.05036365e-006	6.09492650e-004	-1.79427236e-006	2.338878e-003	0.0004	42								
183	1	(grouped with 184_1)													
182	1	9.31364571e-006	6.24912932e-004	-2.84500763e-006	2.418508e-003	0.0003	25								
181	1	1.66782395e-006	5.71395515e-004	-3.67542094e-007	1.882624e-003	0.0005	44								
180	1	(grouped with 181_1)													
179	1	8.21732475e-006	1.89135720e-004	-2.49999890e-006	3.585721e-003	0.0005	26								
178	1	8.11707228e-006	1.24818302e-004	-2.48566469e-006	4.372921e-003	0.0004	31								
177	1	5.01861440e-006	1.85703446e-004	-1.52											

Table 3.1.7. Same as Table 3.1.6, but for leg 2.

STN	CAST	C0	C1	C2	C3	ADEV	NUM
127	4	1.60096925e-005	-2.31849095e-004	-5.09262295e-006	4.002200e-003	0.0003	33
125	2	1.45066917e-005	2.65489176e-004	-4.63099435e-006	2.507485e-003	0.0005	29
120	1	1.20243482e-005	3.44556409e-004	-3.82550676e-006	2.569366e-003	0.0005	31
119	1	1.55241523e-005	4.18790606e-004	-4.85113891e-006	1.750518e-003	0.0004	33
118	1	1.56280140e-005	5.90327476e-004	-4.99615201e-006	1.773563e-003	0.0004	30
117	1	1.40123154e-005	3.81476800e-004	-4.45601954e-006	2.414953e-003	0.0005	32
116	1	9.37686789e-006	9.98721456e-005	-2.98840926e-006	3.069497e-003	0.0003	32
115	1	1.83487197e-005	3.23552670e-004	-5.81414005e-006	3.014449e-003	0.0004	32
114	1	1.51957739e-005	3.73878103e-004	-4.81316163e-006	2.457442e-003	0.0007	30
113	1	4.10622780e-006	6.71247445e-004	-1.26102321e-006	9.223753e-004	0.0003	32
112	1	8.35680011e-006	5.76530317e-004	-2.58491374e-006	1.182687e-003	0.0007	32
111	1	4.40602524e-006	-2.06597593e-004	-1.36331262e-006	3.919643e-003	0.0005	30
110	1	8.22362270e-006	-1.89586126e-004	-2.69855927e-006	4.434407e-003	0.0006	27
109	1	1.00212407e-005	2.49361399e-004	-3.15810536e-006	2.662811e-003	0.0005	31
108	1	1.29927747e-005	4.50114261e-004	-4.11000979e-006	2.166668e-003	0.0005	28
X17	2	1.06543944e-005	4.80189795e-004	-3.39930315e-006	2.445633e-003	0.0006	28
106	1	2.33321401e-005	3.31859944e-004	-7.45259243e-006	2.977453e-003	0.0007	29
105	1	8.05917189e-006	-1.65045722e-003	-2.51821705e-006	9.074284e-003	0.0005	29
104	1	2.03247888e-005	4.31870097e-004	-6.49625041e-006	2.733146e-003	0.0004	28
103	1	1.11247507e-005	-2.67226908e-004	-3.51547513e-006	4.244473e-003	0.0004	29
102	1	2.26641065e-005	4.15016643e-004	-7.18589700e-006	1.992428e-003	0.0006	29
101	1	1.79694387e-005	-5.21909572e-004	-5.80346576e-006	6.162435e-003	0.0004	28
100	1	1.94579284e-005	5.74671974e-004	-6.19715917e-006	2.020458e-003	0.0003	28
099	1	4.44019797e-006	4.41236875e-004	-1.34214493e-006	1.695179e-003	0.0006	29
098	1	1.17086812e-005	4.60939194e-004	-3.69067181e-006	1.783707e-003	0.0004	29
097	1	2.29664660e-005	1.11272451e-004	-7.33008262e-006	4.319058e-003	0.0004	29
096	1	2.52740622e-005	1.75757128e-004	-8.12218768e-006	4.474658e-003	0.0003	25
095	1	1.40392504e-005	1.58358691e-004	-4.41168561e-006	3.449537e-003	0.0004	22
094	1	1.69535773e-005	7.01565075e-004	-5.37245903e-006	1.118249e-003	0.0002	27
093	1	1.39626792e-005	6.55522357e-004	-4.35128124e-006	1.579819e-003	0.0009	21
092	1	1.51949904e-005	1.96221023e-004	-4.80503820e-006	3.284795e-003	0.0004	27
091	1	2.83718571e-005	6.28157739e-004	-9.05163593e-006	1.912157e-003	0.0005	22
090	1	9.48933593e-006	1.99762935e-004	-2.96585247e-006	2.653749e-003	0.0003	27
089	1	1.25632314e-005	1.35573839e-004	-4.13240113e-006	3.959579e-003	0.0004	23
088	1	9.86832859e-006	2.78405943e-004	-3.15267572e-006	2.530385e-003	0.0005	24
087	1	1.67632354e-005	3.19108052e-004	-5.29970304e-006	2.372513e-003	0.0008	22
086	1	1.15863593e-005	2.11859725e-004	-3.69764809e-006	3.300483e-003	0.0006	25
085	1	2.51191800e-005	5.95248399e-004	-8.03908224e-006	2.187668e-003	0.0006	25
084	1	8.29392470e-006	3.88808095e-004	-2.62769212e-006	1.983113e-003	0.0003	26
083	1	9.17454160e-006	8.92111651e-004	-2.91144448e-006	4.747475e-004	0.0004	26
082	1	6.98337086e-006	1.51058249e-004	-2.17102451e-006	2.817945e-003	0.0003	25
081	1	8.12400027e-006	-1.77515840e-005	-2.60753675e-006	3.986962e-003	0.0002	23
080	1	8.16475603e-006	6.22410195e-004	-2.60417115e-006	1.448883e-003	0.0003	19
079	1	5.79417592e-006	-8.32877822e-004	-1.93839249e-006	6.549927e-003	0.0005	26
078	1	7.22760344e-006	-1.36012433e-003	-2.35870118e-006	8.419678e-003	0.0007	48
077	1	(grouped with 078_1)					
076	1	1.51548565e-005	-4.27964129e-004	-4.89673209e-006	5.473128e-003	0.0005	24
075	1	1.48965753e-005	4.86664203e-004	-4.74683919e-006	2.350944e-003	0.0005	24
072	1	2.58477027e-005	-1.00266940e-004	-8.42639144e-006	5.416360e-003	0.0009	22
071	1	1.92143216e-005	-4.71830655e-004	-6.23062332e-006	5.971606e-003	0.0005	23
070	1	1.79631231e-005	-1.35110736e-004	-5.83106586e-006	4.753136e-003	0.0008	46
069	1	(grouped with 070_1)					
068	1	1.07442806e-005	-5.30063376e-004	-3.49712754e-006	5.786034e-003	0.0009	23
067	1	7.36843937e-006	9.99780900e-004	-2.27659194e-006	3.984857e-003	0.0005	30
066	1	-1.68449206e-005	-1.61601505e-003	5.53909973e-006	7.238042e-003	0.0005	21
065	1	5.70020560e-006	7.87708481e-004	-1.74420388e-006	9.414940e-004	0.0003	21
064	1	1.06798064e-005	-3.21153103e-005	-3.41776198e-006	3.872670e-003	0.0004	24
063	1	3.51624683e-006	-1.41559831e-003	-1.10736945e-006	8.261195e-003	0.0006	25
062	1	1.00565727e-005	-3.66899992e-004	-3.31729557e-006	5.578486e-003	0.0005	26
061	1	4.19859030e-006	-1.03551962e-003	-1.39411940e-006	6.985349e-003	0.0008	52
060	1	(grouped with 061_1)					
059	1	7.03279568e-006	-4.08933658e-004	-2.27647752e-006	4.965680e-003	0.0002	24
X18	1	-2.99230565e-007	-2.75624574e-004	1.05381070e-007	4.061828e-003	0.0006	28
056	1	-2.37662229e-007	-6.24097370e-004	1.91933691e-008	5.701486e-003	0.0006	27
055	1	5.92242781e-006	1.24142899e-003	-1.85744158e-006	-7.199049e-004	0.0005	27
054	1	1.03747959e-005	-3.50573579e-004	-3.32438149e-006	5.199271e-003	0.0006	26
053	1	-1.37295616e-006	3.91326178e-004	4.40515980e-007	2.230503e-003	0.0006	28
052	1	5.48862411e-006	-4.25882955e-005	-1.72550879e-006	3.768952e-003	0.0005	28
051	1	5.07750038e-006	6.33855958e-004	-1.58453442e-006	1.228957e-003	0.0002	28
050	1	1.81210638e-006	6.86510324e-004	-5.22058924e-007	9.303875e-004	0.0004	22
049	1	2.98772870e-007	2.74029563e-004	-1.13222551e-007	2.452574e-003	0.0005	28
048	1	3.96688009e-006	-7.26065244e-004	-1.31807618e-006	6.271469e-003	0.0005	27
047	1	9.04719375e-006	-5.28276115e-005	-2.84305324e-006	3.617206e-003	0.0004	26
046	1	6.36260472e-006	4.14011299e-004	-2.03196946e-006	2.306912e-003	0.0009	25
045	1	-2.89527664e-007	-8.54108128e-005	9.40290869e-008	3.565308e-003	0.0004	27
044	2	1.67326574e-006	-1.36121522e-004	-4.89649043e-007	3.403952e-003	0.0006	28
043	1	1.41208284e-006	-2.08855015e-004	-4.68231433e-007	4.192787e-003	0.0005	51
042	1	(grouped with 043_1)					
041	1	-3.78283851e-007	-1.19945908e-003	7.75847481e-008	7.428228e-003	0.0005	48
040	1	(grouped with 041_1)					
039	1	6.41841101e-006	8.43548604e-005	-2.04763155e-006	3.184993e-003	0.0004	28
038	1	-7.84413083e-007	9.30432200e-005	2.39650945e-007	3.189844e-003	0.0005	25
037	1	-1.23076885e-005	-5.38586903e-004	3.87899630e-006	5.288723e-003	0.0005	27
036	1	-1.99653060e-006	-5.42498096e-004	5.92262536e-007	5.435406e-003	0.0005	24
X19	1	2.92471870e-006	3.24367422e-004	-8.83683236e-007	1.833603e-003	0.0003	24
034	1	1.94008435e-005	2.10998151e-004	-6.14878222e-006	2.919276e-003	0.0004	28
033	1	3.85067889e-006	-6.91888977e-005	-1.21536039e-006	3.370414e-003	0.0007	28
032	1	9.18534831e-006	3.82437966e-004	-2.87762345e-006	1.904242e-003	0.0003	27
031	1	5.51058716e-006	-5.44278976e-004	-1.76952146e-006	5.460779e-003	0.0006	29
030	1	-4.15096515e-006	-4.95189143e-004	1.25902239e-006	5.740019e-003	0.0004	25
029	1	5.03439762e-006	-8.37157827e-004	-1.62905040e-006	6.367002e-003	0.0003	27
028	1	1.08962451e-006	-1.27350760e-003	-4.32242247e-007	8.051753e-003	0.0004	25
027	1	5.20552058e-007	-5.01310568e-004	-1.52551105e-007	4.856422e-003	0.0004	27
026	1	4.18383915e-006	-9.95425350e-004	-1.36184864e-006	6.998052e-003	0.0006	28
025	1	4.83074409e-006	-2.97602030e-004	-1.49744447e-006	3.934537e-003	0.0005	26
024	1	-3.67334058e-006	-7.57246379e-004	1.12191531e-006	5.784922e-003	0.0006	28
023	1	1.04517667e-005	-6.52969936e-004	-3.36592828e-006	6.170618e-003	0.0006	50
022	1	(grouped with 023_1)					
021	1	2.17252686e-007	-9.47641934e-004	-8.75053079e-008	6.572313e-003	0.0006	26
020	1	-2.78325647e-007	-8.64399004e-004	6.643896515e-008	6.505357e-003	0.0005	53
019	1	(grouped with 020_1)					
018	1	-3.1					

Table 3.1.8. Same as Table 3.1.6, but for leg 4.

STN	CAST	C0	C1	C2	C3	ADEV	NUM
622	1	8.24466088e-006	1.57561087e-003	-2.38716803e-006	-4.694306e-003	0.0015	66
623	1	(grouped with 622_1)					
624	1	(grouped with 622_1)					
625	1	(grouped with 622_1)					
626	1	(grouped with 622_1)					
627	1	(grouped with 622_1)					
628	1	-7.72755984e-006	1.42733640e-005	2.53791102e-006	2.779590e-004	0.0011	80
629	1	(grouped with 628_1)					
630	1	(grouped with 628_1)					
631	1	(grouped with 628_1)					
632	1	7.84805038e-007	7.18393369e-004	-7.46349019e-008	-2.360764e-003	0.0009	22
001	1	2.49984579e-007	6.90580998e-004	6.55718628e-008	-1.601801e-003	0.0010	26
002	1	2.73668077e-006	1.05649748e-003	-6.09787734e-007	-3.378457e-003	0.0008	55
003	1	(grouped with 002_1)					
004	1	3.30982069e-006	1.22016440e-003	-8.36614761e-007	-3.515901e-003	0.0005	26
005	1	1.70477403e-006	7.38726165e-004	-2.72422503e-007	-2.016103e-003	0.0010	28
006	1	1.57017271e-006	2.18999639e-004	-3.42244980e-007	2.657153e-005	0.0007	28
007	1	4.54235134e-006	1.11068638e-003	-1.24689490e-006	-2.822972e-003	0.0007	26
008	1	1.01574820e-006	1.30035166e-003	-1.41824587e-007	-3.610257e-003	0.0008	24
009	1	2.88518758e-007	1.35315005e-005	2.43562058e-008	1.025170e-003	0.0006	25
010	1	1.89032160e-006	1.01021255e-003	-4.75475294e-007	-1.896583e-003	0.0008	28
011	1	4.22070865e-006	6.79095382e-004	-1.12037258e-006	-2.103258e-003	0.0010	31
X17	1	6.95603050e-006	1.09315498e-003	-1.95357940e-006	-3.185929e-003	0.0005	25
013	1	-2.36044427e-006	1.62672945e-003	8.96518703e-007	-4.857742e-003	0.0006	27
014	1	-5.25945653e-006	9.98132665e-004	1.80694746e-006	-2.567029e-003	0.0005	50
015	1	(grouped with 014_1)					
016	1	4.28382492e-007	7.39832156e-005	5.57343759e-008	1.035969e-003	0.0014	21
X23	1	6.24746070e-006	1.35893675e-004	-1.80417262e-006	1.063619e-003	0.0011	20
018	1	6.77972144e-006	6.05964588e-004	-1.97508985e-006	-3.321299e-004	0.0011	54
019	1	(grouped with 018_1)					
020	1	(grouped with 018_1)					
021	1	7.75255043e-006	5.92430724e-004	-2.26648005e-006	-1.642034e-004	0.0010	21
022	1	1.24400763e-005	6.53731821e-004	-3.74482868e-006	-2.611572e-004	0.0007	20
023	1	-2.85049400e-006	8.91836818e-004	1.28104955e-006	-1.925115e-003	0.0008	55
024	1	(grouped with 023_1)					
025	1	(grouped with 023_1)					
026	1	2.6505658e-006	9.35278165e-004	-6.58943954e-007	-1.767912e-003	0.0007	51
027	1	-6.31621570e-007	1.37702100e-003	4.59951783e-007	-4.258577e-003	0.0003	27
028	1	(grouped with 026_1)					
029	1	4.72566904e-006	8.73963940e-004	-1.35695047e-006	-1.565746e-003	0.0006	84
030	1	(grouped with 029_1)					
031	1	(grouped with 029_1)					
032	1	-9.24401907e-007	7.17363727e-004	4.29856395e-007	-1.619151e-003	0.0007	26
033	1	1.57971762e-006	7.25679308e-004	-3.61488808e-007	-1.025822e-003	0.0005	26
034	1	5.42176058e-006	4.64870913e-004	-1.55912539e-006	6.214506e-005	0.0008	138
035	1	(grouped with 034_1)					
036	1	(grouped with 034_1)					
037	1	(grouped with 034_1)					
038	1	(grouped with 034_1)					
039	1	2.33647568e-006	6.26961319e-004	-5.33630125e-007	-1.069787e-003	0.0006	30
X16	1	1.78217003e-006	8.51290941e-004	-4.07064690e-007	-1.088936e-003	0.0008	90
041	1	(grouped with X16_1)					
042	1	(grouped with X16_1)					
043	1	2.26019471e-006	1.19790631e-003	-5.37505061e-007	-2.500387e-003	0.0005	60
044	1	(grouped with 043_1)					
045	1	4.70295566e-006	6.90234604e-004	-1.27546314e-006	-1.094622e-003	0.0008	32
046	1	-4.40922586e-006	7.54992793e-004	1.55059893e-006	-1.349111e-003	0.0005	32
X15	1	5.14772965e-006	8.61752613e-004	-1.40424108e-006	-1.862612e-003	0.0008	32
048	1	5.72750294e-006	1.25176363e-003	-1.60942049e-006	-2.537675e-003	0.0006	28
049	1	-2.08152101e-006	1.52439728e-003	8.56785071e-007	-3.629352e-003	0.0007	29
050	1	4.74646838e-007	9.79015226e-004	3.43528792e-008	-1.554232e-003	0.0008	24
051	1	-1.17247204e-005	8.31258304e-004	3.86523902e-006	-1.769965e-003	0.0005	28
052	1	5.60590683e-006	3.52090148e-004	-1.58594000e-006	9.875759e-004	0.0007	25
053	1	3.23773029e-007	4.42676884e-004	5.83918895e-008	1.692069e-004	0.0005	29
054	1	-4.41877391e-006	4.82538473e-004	1.43260841e-006	9.877304e-004	0.0007	23
055	1	3.26014413e-006	-1.63209850e-004	-9.41154797e-007	3.382969e-003	0.0012	22
056	1	-5.24937354e-006	6.54777696e-004	1.80772573e-006	-3.308948e-004	0.0009	51
057	1	(grouped with 056_1)					
058	1	-1.19523696e-005	8.06616797e-004	3.89130953e-006	-9.053909e-004	0.0006	26
059	1	-2.23262272e-007	-2.76130244e-004	2.03849118e-007	2.962791e-003	0.0008	27
060	1	-2.44325157e-006	2.09752664e-004	9.29026895e-007	1.038234e-003	0.0005	28
061	1	3.84528619e-006	9.70509341e-004	-1.01568581e-006	-1.156196e-003	0.0006	28
X14	1	-6.82058929e-006	3.82235858e-004	2.25166266e-006	1.043727e-003	0.0004	28
063	1	-1.43864740e-007	7.75314328e-004	1.72494419e-007	-2.894878e-004	0.0005	26
064	1	2.17794538e-006	3.14169041e-004	-5.23176328e-007	9.945333e-004	0.0005	26
065	1	-4.06221559e-006	2.82751267e-004	1.32753555e-006	1.651734e-003	0.0004	29
066	1	4.15879145e-006	1.53396445e-003	-1.10787340e-006	-3.154008e-003	0.0005	28
067	1	-1.12308096e-005	-3.79582731e-004	3.56818041e-006	3.372584e-003	0.0004	27
068	1	-1.12116653e-005	4.61150814e-005	3.53049404e-006	2.625733e-003	0.0005	85

069	1	(grouped with 068_1)					
070	1	(grouped with 068_1)					
071	1	-1.26747763e-005	-2.00840616e-004	3.92914781e-006	3.883769e-003	0.0005	54
072	1	(grouped with 071_1)					
073	1	-3.03306565e-006	1.61672157e-003	1.19298946e-006	-4.197925e-003	0.0011	28
074	1	-2.36105504e-005	1.23543997e-003	7.66150721e-006	-3.000897e-003	0.0007	24
075	1	-1.68502925e-005	9.04435647e-004	5.39351251e-006	-6.705600e-004	0.0010	71
076	1	(grouped with 075_1)					
077	1	(grouped with 075_1)					
078	1	-1.27215884e-007	2.43829405e-003	2.56226048e-007	-6.319276e-003	0.0010	156
079	1	(grouped with 078_1)					
080	1	(grouped with 078_1)					
081	1	(grouped with 078_1)					
082	1	(grouped with 078_1)					
083	1	5.60729617e-006	1.85828831e-003	-1.54423942e-006	-4.527516e-003	0.0011	33
084	1	5.63740768e-006	1.74853624e-003	-1.59303715e-006	-3.849752e-003	0.0007	62
085	1	(grouped with 084_1)					
086	1	5.71119403e-006	1.52063196e-003	-1.63260596e-006	-2.835121e-003	0.0008	30
087	1	2.10911679e-006	1.61542518e-003	-5.01312019e-007	-3.187693e-003	0.0007	65
X13	1	(grouped with 087_1)					
089	2	-4.89895023e-007	1.52287953e-003	3.16504361e-007	-2.522387e-003	0.0008	29
090	1	-9.57506340e-006	8.21533287e-004	3.18407810e-006	-6.891242e-004	0.0009	28
091	1	-2.55316193e-005	1.06583682e-003	8.14813509e-006	-2.040584e-003	0.0005	28
092	1	-2.32074246e-005	1.24389610e-004	7.33658393e-006	1.993603e-003	0.0006	25
093	1	-1.77733944e-005	-1.13142403e-004	5.60671427e-006	3.352599e-003	0.0006	27
094	1	-2.71043477e-005	1.12742780e-003	8.63314944e-006	-1.703758e-003	0.0007	24
095	1	-7.67177610e-005	1.04296472e-003	2.39906277e-005	-1.868357e-003	0.0007	24
096	1	-4.95997394e-005	1.89563680e-004	1.54703967e-005	2.066740e-003	0.0015	21
097	1	-3.81008901e-005	1.44265298e-003	1.22235289e-005	-2.557692e-003	0.0010	32
098	1	(grouped with 097_1)					
099	1	(grouped with 097_1)					
100	1	(grouped with 097_1)					

(6.4) Oxygen

The CTD oxygen is calibrated using the oxygen model (see 4.4) as

$$\begin{aligned} & \text{Calibrated oxygen (ml/l)} \\ & = \{(Soc + dSoc) * \{v + offset + doffset\} * \exp\{(TCor + dTCor) * t + (PCor + dPCor) * p\}\} \\ & * Oxsat(t, s) \end{aligned}$$

where p is pressure in dbar, t is absolute temperature and s is salinity in psu. Oxsat is oxygen saturation value minus the volume of oxygen gas (STP) absorbed from humidity-saturated air (see 4.4). Soc, offset, TCor and PCor are the pre-cruise calibration coefficients (see 4.4) and dSoc, doffset, dTCor and dPCor are calibration coefficients. The best fit sets of coefficients are determined by minimizing the sum of absolute deviation with a weight from the bottle oxygen data. The MATLAB[®] function FMINSEARCH is used to determine the sets. The weight is given as a function of vertical oxygen gradient and pressure as

$$\text{Weight} = \min[4, \exp\{\log(4) * Gr / Grad\}] * \min[4, \exp\{\log(4) * P^2 / PR^2\}]$$

where Grad is vertical oxygen gradient in $\mu\text{mol kg}^{-1} \text{ dbar}^{-1}$, P is pressure in dbar. Gr and PR are threshold of the oxygen gradient (default value is $0.3 \mu\text{mol kg}^{-1} \text{ dbar}^{-1}$) and pressure (1,000 dbar), respectively. When oxygen gradient is small (large) and pressure is large (small), the weight is large (small) at maximum (minimum) value of 16 (1). The oxygen gradient is calculated using up-cast CTD oxygen data. The up-cast CTD oxygen data is low-pass filtered with a 3-point (weights are 1/4, 1/2, 1/4) triangle filter before the calculation.

The calibration is performed for the output from following oxygen sensor:

Leg 1: primary (S/N 0390) with secondary temperature and salinity data

Leg 2: primary (S/N 0391)

Leg 4: primary (S/N 0391)

Leg 5: primary (S/N 0391) except for I04_597 and I03_503

secondary (S/N 0205) for I04_597 and I03_503

The down-cast CTD data sampled at same density of the CTD data created by the software module ROSSUM are used after the post-cruise calibration for the CTD temperature and salinity.

The coefficients are basically determined for each station. Some stations, especially for shallow stations, are grouped for determining the calibration coefficients. Following stations are exceptionally grouped with fixing only the coefficient dTCor in order to obtain better result.

P06_175 & P06_174, P06_122 & P06_121, P06_011 & P06_010 & P06_009,
I03_546 & I03_545, I03_531 & I03_530, I03_528 & I03_527, I03_515 & I03_514,
I03_505 & I03_504 & I03_503, I03_452 & I03_451 & I03_450

Two examples of the calibration are shown in Figure 3.1.15 and Figure 3.1.16. For leg 1, the secondary oxygen sensor (S/N 0205) data could not be calibrated with sufficient accuracy through this calibration method (Figure 3.1.15). Therefore the primary oxygen sensor (S/N 0390) data are used with secondary temperature and salinity data (Figure 3.1.16).

The results of the post-cruise calibration for the CTD oxygen are summarized in Table 3.1.10 and shown in Figure 3.1.22 to Figure 3.1.25. And the calibration coefficients, the mean absolute deviation (ADEV) from the bottle oxygen and the number of the data (NUM) used for the calibration are listed in Table 3.1.11 to Table 3.1.14.

Table 3.1.10. Difference between the CTD oxygen and the bottle oxygen after the post-cruise calibration. Mean and standard deviation (Sdev) are calculated below and above 1,000 dbar for each leg. Number of data used is also shown.

Leg	Pressure \geq 1,000 dbar			Pressure $<$ 1,000 dbar		
	Num	Mean	Sdev	Num	Mean	Sdev
		($\mu\text{mol/kg}$)	($\mu\text{mol/kg}$)		($\mu\text{mol/kg}$)	($\mu\text{mol/kg}$)
Leg 1	1776	0.00	0.59	1581	-0.25	2.58
Leg 2	1570	0.09	0.71	1532	0.00	2.98
Leg 4	1438	-0.06	0.76	1412	-0.02	2.78
Leg 5	2088	0.00	1.14	1881	0.34	3.27

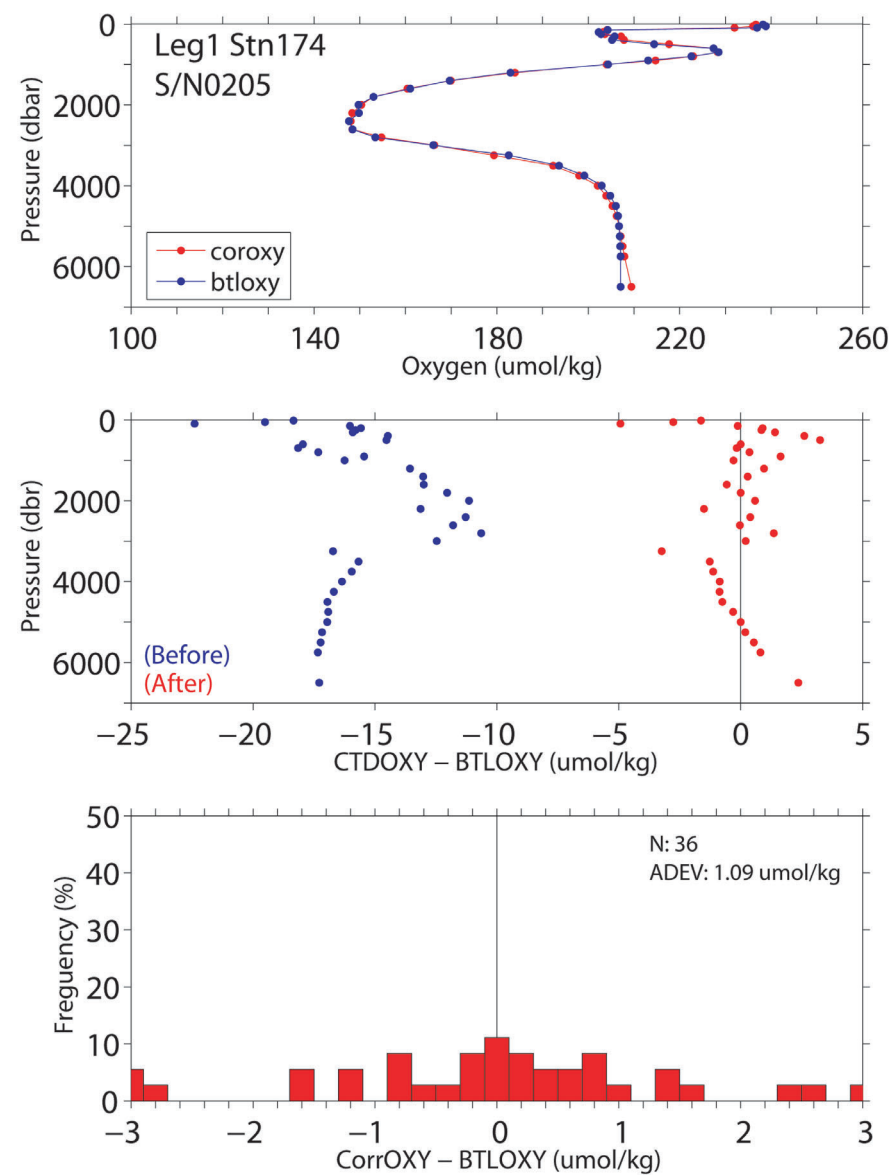

Figure 3.1.20. An example of difference between the CTD oxygen and the bottle oxygen (leg 1, P06_174) for secondary oxygen sensor (S/N 0205). Upper panel shows vertical profile of bottle oxygen (blue) and calibrated CTD oxygen (red). Middle panel shows vertical distribution of the difference (blue: before the calibration, red: after the calibration). Lower panel shows histogram of the difference after the calibration.

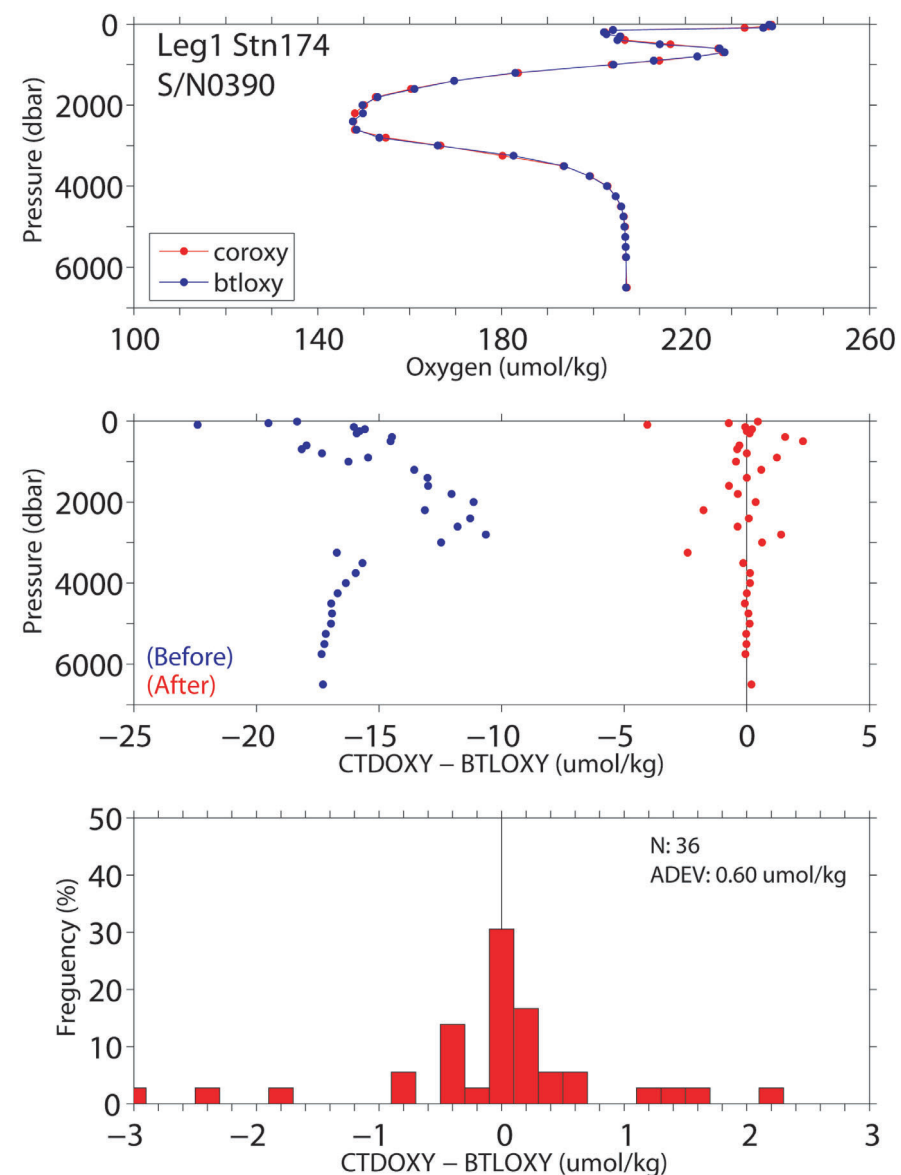

Figure 3.1.21. Same as Figure 3.1.20, but for primary oxygen sensor (S/N 0390).

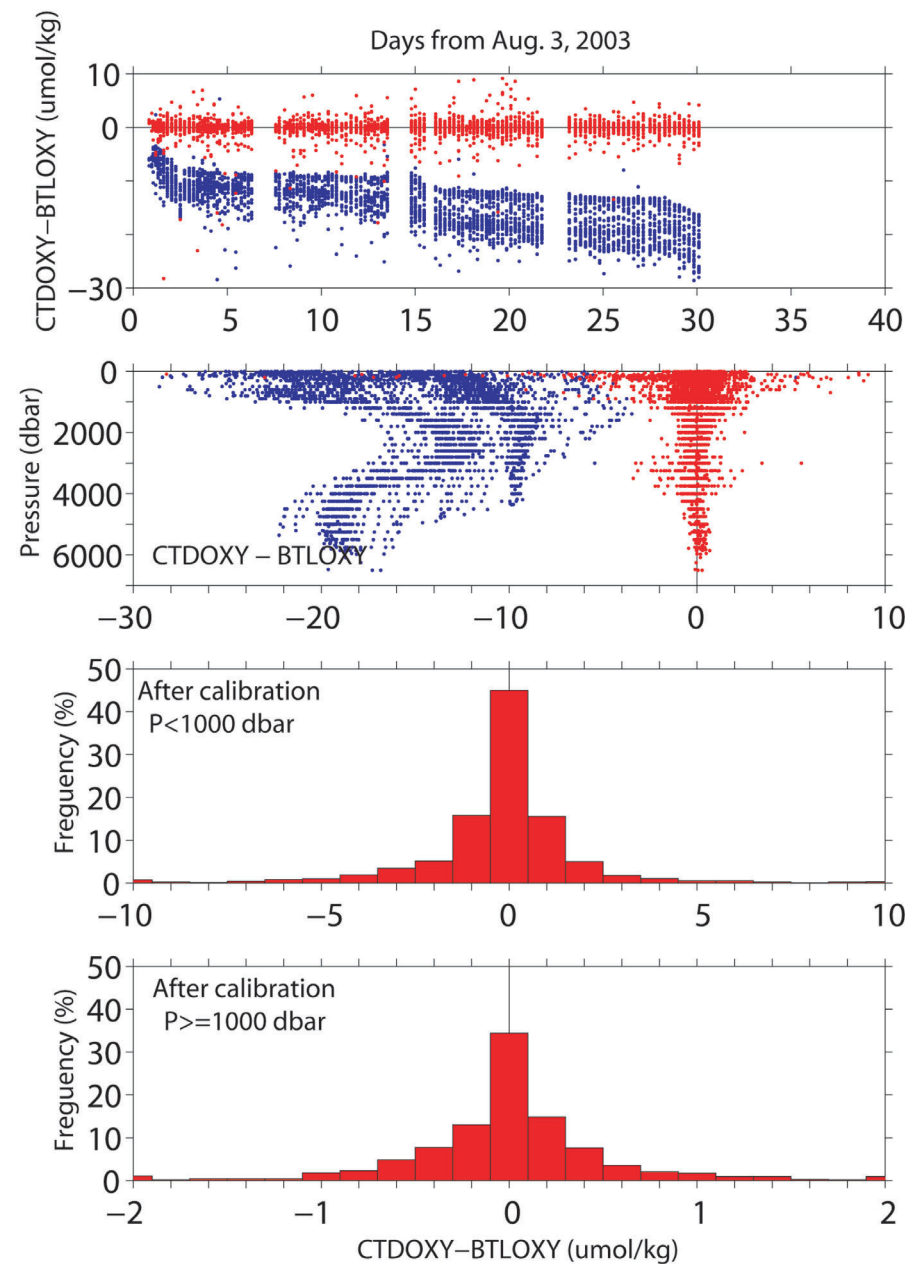

Figure 3.1.22. Difference between the CTD oxygen and the bottle oxygen for leg 1. Blue and red dots indicate before and after the post-cruise calibration using the bottle oxygen data, respectively. Lower two panels show histogram of the difference after the calibration.

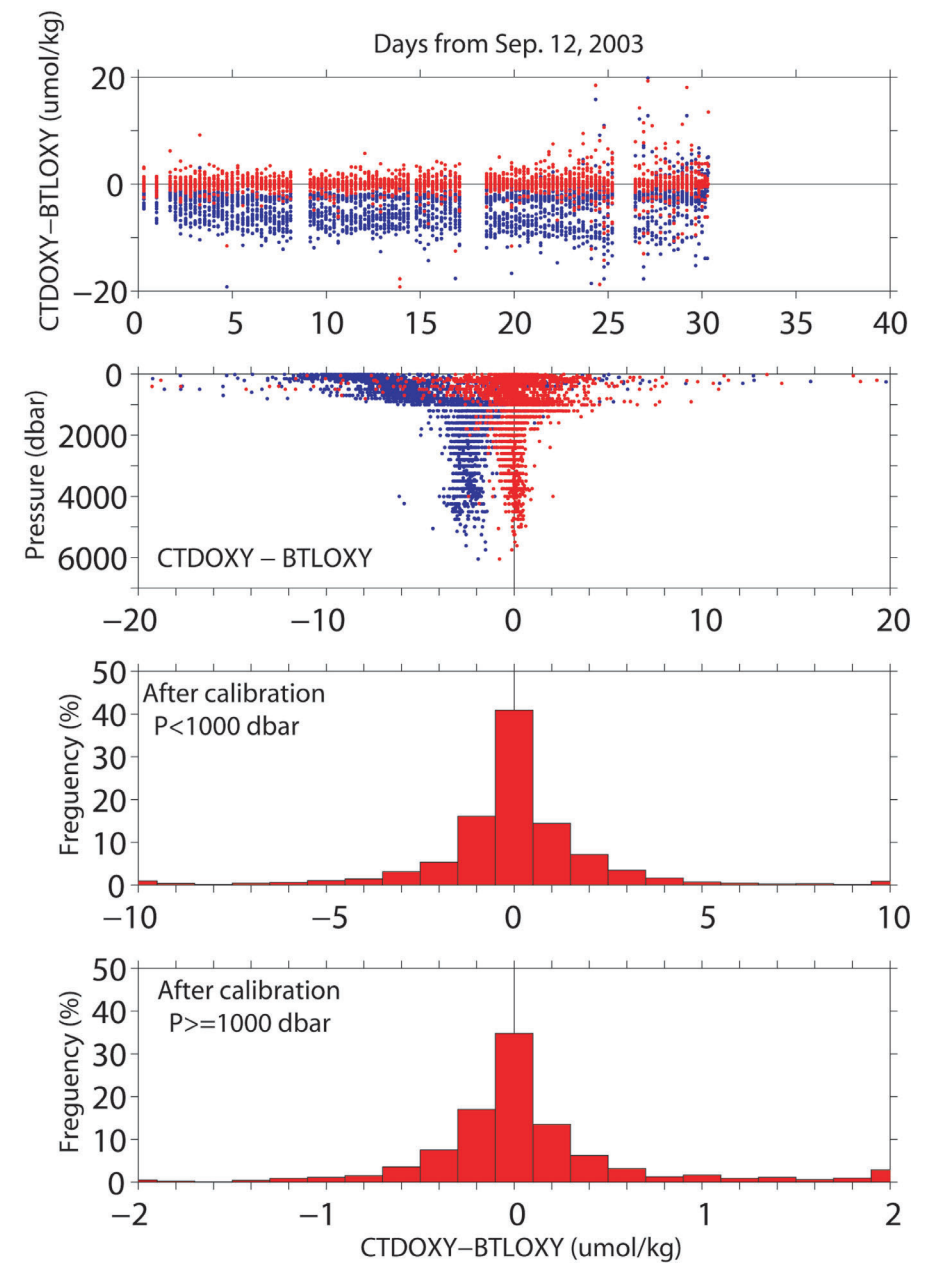

Figure 3.1.23. Same as Figure 3.1.22, but for leg 2.

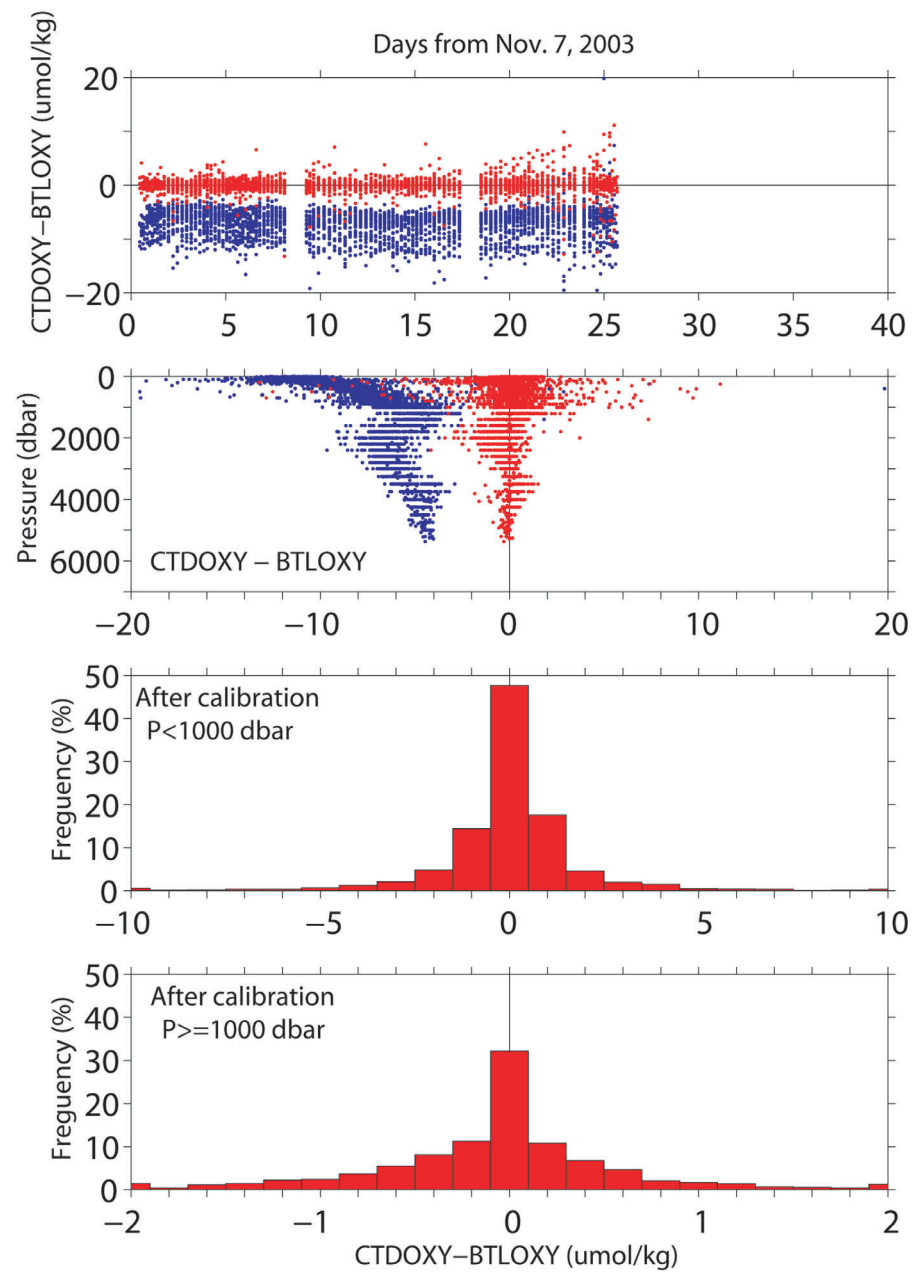

Figure 3.1.24. Same as Figure 3.1.22, but for leg 4.

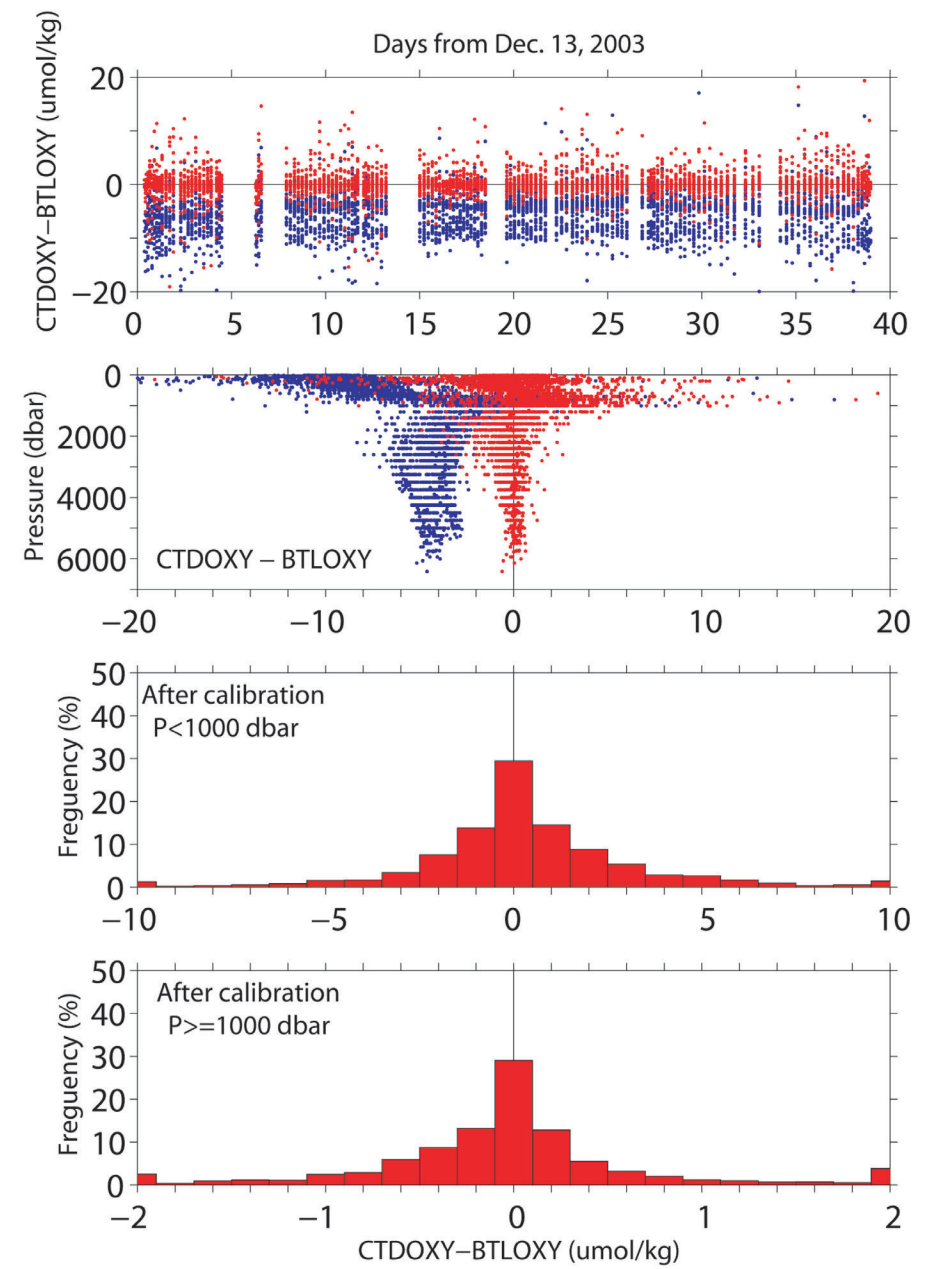

Figure 3.1.25. Same as Figure 3.1.22, but for leg 5.

Table 3.1.11. Calibration coefficients of CTD oxygen for leg 1.

STN	CAST	dsOC	doffset	dTCor	dPCor	ADEV	NUM
246	1	2.38582090e-003	1.887111e-003	1.48955051e-003	1.01158483e-005	1.0222	41
245	1	(grouped with 246_1)					
244	1	(grouped with 246_1)					
243	1	(grouped with 246_1)					
242	1	1.96219702e-002	-4.768921e-002	-1.69310871e-004	8.28571766e-006	0.8231	18
241	1	2.09523345e-002	-6.285339e-002	4.55776312e-004	1.25161338e-005	0.9124	24
240	1	7.32701374e-003	-1.965882e-002	1.51889513e-003	1.18141936e-005	1.5916	30
239	1	1.09973336e-002	7.086056e-003	5.81005416e-004	4.63627641e-006	0.7618	30
238	1	1.52088062e-002	-2.687566e-002	1.06131300e-003	1.07691510e-005	0.5609	30
237	1	1.69483728e-002	-1.832307e-002	6.52204023e-004	7.58211796e-006	0.5598	31
X11	1	2.30535862e-002	5.414177e-002	-1.12186694e-003	-9.19460122e-006	1.3567	33
235	1	1.92487631e-002	-1.587548e-002	-8.45506001e-006	6.43657688e-006	0.3632	29
234	1	1.70941074e-002	-6.287279e-003	3.24244778e-004	5.65441573e-006	0.5210	23
232	1	1.96361830e-002	-2.157541e-002	5.03860863e-004	8.02631561e-006	0.7912	32
231	1	8.52011498e-003	7.824986e-003	1.98053266e-003	1.06535798e-005	2.9007	24
230	1	1.66220798e-002	-3.093979e-002	1.19719391e-003	1.67226710e-005	0.5738	17
229	1	2.17858207e-002	-9.793618e-003	4.63808386e-006	2.11889898e-007	1.2303	19
228	1	1.70203655e-002	-6.999983e-003	7.52699424e-004	6.36132952e-006	0.7301	22
227	1	1.27340850e-002	-1.081054e-003	1.52753424e-003	9.67463030e-006	0.9325	23
226	1	1.27356348e-002	2.370764e-002	8.65588505e-004	-7.88346212e-007	0.7562	18
225	1	1.34323389e-002	-4.777866e-003	1.36717210e-003	1.00117132e-005	1.1864	35
224	1	(grouped with 225_1)					
223	1	1.72491859e-002	-7.885494e-003	8.95765560e-004	6.08006705e-006	1.2634	116
222	1	(grouped with 223_1)					
221	1	(grouped with 223_1)					
220	1	(grouped with 223_1)					
219	1	(grouped with 223_1)					
218	1	(grouped with 223_1)					
217	1	(grouped with 223_1)					
216	1	1.43851861e-002	-1.334883e-002	8.36621684e-004	1.05968498e-006	0.4325	26
215	1	1.60120845e-002	1.408044e-004	1.02632654e-003	3.80264393e-006	0.5611	26
214	1	1.54383735e-002	2.469768e-003	1.01120263e-003	4.31263793e-006	0.5565	26
213	1	1.97484020e-002	-1.293050e-002	6.86284387e-004	4.56955146e-006	0.6883	42
212	1	(grouped with 213_1)					
211	1	1.15339829e-002	2.352442e-002	1.30678348e-003	-3.50720791e-007	0.4582	22
210	1	1.19521280e-002	3.787796e-002	1.03716016e-003	-5.87638101e-006	0.7936	52
209	1	(grouped with 210_1)					
208	1	(grouped with 210_1)					
207	1	1.83647636e-002	-2.022739e-003	5.82575411e-004	2.38730414e-006	0.9064	48
206	1	(grouped with 207_1)					
205	1	1.57243966e-002	1.256451e-002	8.92227219e-004	-6.59272746e-007	0.9430	47
204	1	(grouped with 205_1)					
203	1	1.68041639e-002	1.254249e-003	9.05164341e-004	2.83191955e-006	0.6897	73
202	1	(grouped with 203_1)					
201	1	(grouped with 203_1)					
200	1	(grouped with 203_1)					
199	1	1.90164157e-002	2.312641e-003	3.92984271e-004	-5.77434750e-009	0.4700	59
198	1	(grouped with 199_1)					
197	1	(grouped with 199_1)					
196	1	5.14578578e-003	4.544205e-002	2.36327120e-003	-1.84873190e-006	0.8618	26
195	1	1.56669191e-002	1.236898e-002	7.19222256e-004	-3.77852598e-007	0.3629	27
194	1	1.15354963e-002	3.361402e-002	1.39325069e-003	-4.21996334e-006	0.8988	28
X14	1	1.84000869e-002	2.649477e-003	7.06666160e-004	1.04379763e-006	0.7189	29
192	1	2.67368609e-002	-2.915823e-002	-6.77651652e-005	5.26758668e-006	0.6830	29
191	1	3.29050209e-002	-5.546260e-002	-7.65931385e-004	9.66482398e-006	0.5235	30
190	1	1.62697194e-002	1.617597e-002	9.33702967e-004	-2.00265537e-006	0.9525	29
186	1	1.69719541e-002	6.763835e-003	1.04352693e-003	1.13618883e-006	0.5401	28
185	1	2.48010752e-002	-2.549541e-002	1.62272759e-004	6.14933921e-006	0.8327	26
184	1	1.87704489e-002	1.051108e-002	4.24005384e-004	-2.19257733e-006	0.9231	42
183	1	(grouped with 184_1)					
182	1	2.20045670e-002	-2.016613e-002	5.53496058e-004	6.10130301e-006	0.5214	25
181	1	1.32249175e-002	3.646574e-002	1.10721356e-003	-6.20976884e-006	1.0281	43
180	1	(grouped with 181_1)					
179	1	1.87222549e-002	-1.477391e-002	1.18836829e-003	8.20735406e-006	1.6390	26
178	1	1.98860517e-002	-1.915872e-002	9.22288924e-004	7.38557353e-006	0.9050	30
177	1	2.06493657e-002	-1.057594e-002	8.18024036e-004	5.28978299e-006	1.1566	32
176	1	2.04550178e-002	-1.075094e-002	1.00851163e-003	5.62614860e-006	0.9945	36
175	1	2.42465264e-002	-1.826848e-002	8.00875863e-005	5.71561698e-006	1.1673	71
174	1	2.82908744e-002	-1.308557e-002	8.00875863e-005	2.99933551e-006	0.6080	71
173	1	3.18702655e-002	-2.685952e-002	1.28591177e-005	4.86180818e-006	0.6253	36
172	1	2.89911863e-002	-9.394000e-003	1.48387045e-004	2.93866278e-006	0.7515	35
171	1	3.15402716e-002	-1.562983e-002	-3.54025098e-004	3.03193404e-006	0.4653	33
170	1	2.92569924e-002	-1.194463e-002	-1.09474305e-004	3.35102881e-006	0.7037	36
169	1	2.68419905e-002	-6.161658e-003	5.92733683e-004	3.53521281e-006	0.8244	35
168	1	3.10648438e-002	-1.645999e-002	-1.52321359e-004	3.79836128e-006	1.6206	34
167	1	3.13862115e-002	-1.431032e-002	1.75003723e-004	3.21061164e-006	0.4295	36
166	1	3.25962716e-002	-2.126453e-002	-2.93401620e-005	4.15446915e-006	0.4985	41
166	2	(grouped with 166_1)					
165	1	3.13416164e-002	-1.742716e-002	-8.10465395e-005	3.98219083e-006	0.9254	72
164	1	(grouped with 165_1)					
163	1	3.48398044e-002	-2.633253e-002	-2.75654449e-004	4.19186733e-006	0.6397	35
162	1	3.04956807e-002	-1.238719e-002	1.10739155e-004	3.65117545e-006	0.5299	30
161	1	3.10885459e-002	-1.369728e-002	2.63961999e-004	3.81475328e-006	0.6977	32
160	1	3.13641340e-002	-1.696865e-002	1.00400571e-004	4.21787756e-006	1.1353	103
159	1	(grouped with 160_1)					
158	1	(grouped with 160_1)					
X15	1	3.35376368e-002	-1.838064e-002	-3.39126912e-004	3.77014859e-006	0.7931	35
156	1	3.77102348e-002	-2.190094e-002	-7.67051284e-004	2.04281956e-006	1.1912	34
155	1	2.91790424e-002	-5.186495e-003	2.70503019e-004	2.80822996e-006	0.8127	34
154	1	3.35985576e-002	-2.160858e-002	-1.11728456e-004	4.47796268e-006	0.7651	34
153	1	3.16556495e-002	-1.145357e-002	4.77295143e-005	3.12465601e-006	0.4189	34
152	1	3.22853325e-002	-9.941596e-003	-2.36615248e-004	2.48648438e-006	0.9098	36
151	1	3.02502361e-002	-5.966700e-003	2.90176684e-004	2.75248141e-006	0.5385	34
150	1	2.81804035e-002	-6.506802e-003	5.75029470e-004	4.19079955e-006	0.8227	34
149	1	3.11456957e-002	-6.967424e-003	5.18660266e-005	2.91721787e-006	0.6199	34
148	1	3.47348862e-002	-1.684690e-002	-2.29582275e-004	2.82516719e-006	0.7443	68
147	1	(grouped with 148_1)					
146	1	3.53410982e-002	-2.046191e-002	-1.11844595e-004	3.43154569e-006	0.3174	34
145	1	3.62919880e-002	-2.120630e-002	-1.55453128e-004	3.34846046e-006	0.5929	66
144	1	(grouped with 145_1)					
143	1	3.36266628e-002	-1.371444e-002	1.55735719e-004	2.97005323e-006	0.5543	32
142	1	3.2608071e-002	-1.343652e-002	7.40464793e-004	3.68768905e-006	0.5138	34
140	1	3.19586591e-002	-9.780018e-003	5.57610736e-004	3.31379058e-006	0.5453	66
139	1	(grouped with 140_1)					
138	1	3.37279205e-002	-9.370842e-003	3.65654229e-005	1.86486177e-006	0.8831	30
137	1	3.63150433e-002	-1.950630e-002	-3.15347606e-004	2.76325448e-006	0.6029	36
136	1	3.22872791e-002	-6.775344e-003	4.30712788e-004	2.06319894e-006	0.9276	34
135	1	3.29996810e-002	-5.472943e-003	3.53114357e-005	1.50420915e-006	0.4154	35
134	1	3.72861207e-002	-2.213754e-002	-2.48397916e-004	2.89717034e-006	0.7042	33
133	1	3.35635774e-002	-1.214661e-002	3.09875111e-004	2.92718053e-006	0.7336	33
132	1	2.72692079e-002	1.837957e-003	1.53006774e-003	3.14546947e-006	0.7034	32
131	1	3.38276184e-002	-1.373936e-002	3.77339262e-004	2.94799311e-006	0.3778	33
130	1	3.45000073e-002	-2.197492e-002	3.59766822e-004	5.83398902e-006	0.5472	26
129	1	3.50350563e-002	-1.245277e-002	-5.87154649e-005	2.05119992e-006	0.8191	34
X16	1	3.23858223e-002	-6.221201e-003	2.23999058e-004	2.09230315e-006	0.5398	66
127	1	(grouped with X16_1)					
126	1	3.58576508e-002	-8.846458e-003	-2.02242075e-004	1.94536337e-006	0.4036	32
125	1	2.96552275e-002	1.562307e-003	1.562307e-003	3.66817745e-006	1.0164	31
124	1	3.13219439e-002	-6.211164e-004	7.46450419e-004	3.82288286e-006	0.7973	31
123	1	4.04501789e-002	-1.358723e-002	-3.54051940e-004	1.85413544e-006	0.5865	34
122	1	3.47054822e-002	6.965114e-003	4.64724281e-004	8.32092898e-007	0.6458	66
121	1	3.60269589e-002	1.461146e-003	4.64724281e-004	1.81556937e-006	0.7168	66

Table 3.1.12. Same as Table 3.1.11, but for leg 2.

STN	CAST	dSOC	doffset	dTCor	dPCor	ADEV	NUM
127	4	-1.09274080e-003	-9.642248e-003	1.50130547e-003	5.30811735e-006	0.5607	33
125	2	1.45679332e-003	-1.657886e-002	1.85376125e-003	6.81714046e-006	0.6603	29
120	1	-7.81977270e-003	1.643640e-002	1.91010375e-003	1.73135670e-006	0.6464	32
119	1	2.45926851e-003	-3.551664e-003	1.27334726e-003	2.05691219e-006	0.4482	33
118	1	8.74016303e-003	-1.883221e-002	9.40779721e-004	4.55476214e-006	0.8577	30
117	1	3.99051347e-004	2.072205e-003	1.62885202e-003	2.37402168e-006	0.5698	32
116	1	7.47493664e-003	-1.627756e-002	1.16633447e-003	4.09526968e-006	0.6458	32
115	1	4.69541047e-003	-8.605837e-003	1.35055494e-003	3.51015996e-006	0.7595	62
114	1	(grouped with 115_1)					
113	1	3.08295193e-003	-5.180368e-003	1.75481716e-003	3.08785085e-006	0.5985	32
112	1	-2.08564354e-003	9.224806e-003	1.94034066e-003	1.30094617e-006	0.6752	32
111	1	1.66887700e-002	-2.838172e-002	-4.57225340e-004	3.86551232e-006	0.6704	30
110	1	1.21875571e-002	-1.875040e-002	5.81443019e-004	2.61866766e-006	0.5569	28
109	1	7.37942776e-003	-9.168366e-003	1.44016227e-003	2.23844225e-006	0.4737	30
108	1	5.82680563e-003	-9.584403e-003	1.65645010e-003	3.24617142e-006	0.9119	30
X17	2	1.22319553e-002	-1.590105e-002	6.65168181e-004	2.10046660e-006	0.4956	29
106	1	1.41271210e-002	-2.608612e-002	6.92971740e-004	4.99233252e-006	0.6274	29
105	1	1.19095315e-002	-1.766180e-002	9.77996680e-004	3.05979585e-006	0.5593	28
104	1	1.01039359e-002	-1.197509e-002	1.11095785e-003	1.74786763e-006	0.4229	30
103	1	1.16737262e-002	-1.721616e-002	7.85935207e-004	2.77226908e-006	0.4831	28
102	1	8.67632966e-003	-1.726645e-002	1.31463987e-003	5.12263247e-006	0.7849	29
101	1	5.43022332e-003	-4.102882e-003	1.63767352e-003	1.65849417e-006	0.6098	27
100	1	1.01358495e-002	-1.799370e-002	1.58545060e-003	4.54472094e-006	0.3997	27
099	1	1.09938825e-002	-1.037107e-002	9.04954968e-004	4.73373066e-007	0.4579	28
098	1	1.19863923e-002	-1.196383e-002	7.70085100e-004	4.88695245e-007	0.5202	27
097	1	1.04906792e-002	-1.161558e-002	9.89786901e-004	1.07592910e-006	0.4959	28
096	1	1.00183012e-002	-1.391625e-002	1.19566599e-003	2.72057855e-006	0.5366	25
095	1	1.26054247e-002	-3.221627e-002	1.32205530e-003	9.93640834e-006	0.4060	21
094	1	-8.79253048e-003	3.318282e-002	3.18228491e-003	-3.22862977e-006	0.6676	27
093	1	2.36744233e-003	-1.182664e-002	2.42565918e-003	8.38307154e-006	0.6600	21
092	1	7.34297175e-003	-8.555440e-003	1.06337858e-003	2.02041928e-006	0.5711	27
091	1	9.74745476e-003	-3.296311e-002	1.50853917e-003	1.26202328e-005	0.4855	22
090	1	1.75626063e-004	9.451891e-003	1.82513675e-003	-4.41355713e-007	0.6162	26
089	1	9.79129790e-003	-2.955496e-002	1.50830787e-003	1.07057009e-005	0.6860	23
088	1	5.89084240e-003	-1.410234e-002	1.63753372e-003	5.96518950e-006	0.5562	24
087	1	-3.63729020e-003	1.564703e-002	2.48632724e-003	-3.15856407e-007	0.6354	24
086	1	1.18997793e-002	-1.099894e-002	-1.37906591e-004	1.49268816e-007	1.1285	25
085	1	7.49243370e-003	-1.322353e-002	1.53041534e-003	4.49091684e-006	0.5874	25
084	1	1.61843752e-002	-2.674799e-002	4.03006384e-004	3.39762207e-006	0.5542	25
083	1	1.10955361e-002	-1.575595e-002	9.59456371e-004	2.14033432e-006	0.5787	27
082	1	1.02702377e-002	-1.283594e-002	1.05576044e-003	1.44338445e-006	0.5816	26
081	1	1.20686931e-002	-1.418798e-002	7.16178313e-004	8.99708179e-007	0.4142	26
080	1	8.81364097e-003	-1.388094e-002	1.14330628e-003	3.45310873e-006	0.6839	20
079	1	1.88905722e-002	-3.427543e-002	1.32864542e-004	4.40922771e-006	0.5470	26
078	1	1.73401052e-002	-3.008971e-002	2.71658744e-004	4.24281896e-006	0.6289	25
077	1	1.14511360e-002	-2.036342e-002	1.02401160e-003	3.72734983e-006	0.5449	25
076	1	1.25188282e-002	-1.710343e-002	1.705872161e-004	1.63736491e-006	0.8367	24
075	1	9.84956264e-003	-2.121272e-002	1.20306827e-003	6.27295106e-006	0.5378	24
072	1	9.74597273e-003	-1.563567e-002	1.09316155e-003	3.29436115e-006	0.6366	22
071	1	6.22872864e-004	9.106210e-003	1.61219720e-003	-2.21128469e-007	0.5449	24
070	1	2.15245527e-003	6.689708e-003	1.62266305e-003	1.01094161e-007	0.6773	22
069	1	1.30137238e-002	-1.386944e-002	5.38979596e-004	5.91962487e-007	2.8002	25
068	1	1.03509138e-002	-1.316118e-002	7.22406700e-004	2.00768809e-006	0.7732	23
067	1	1.98547673e-003	1.717993e-002	1.36832806e-003	-5.23856596e-006	0.5011	31
066	1	1.20119393e-002	-2.653336e-002	9.95283507e-004	7.07856393e-006	0.6510	23
065	1	3.05908526e-003	1.299736e-002	1.19343084e-003	-3.92929871e-006	0.9623	26
064	1	1.34349983e-002	-2.663693e-002	5.97615018e-004	5.79015520e-006	0.6654	25
063	1	1.25716313e-002	-1.237644e-002	5.80223732e-004	-8.72689407e-007	1.0818	27
062	1	7.28264565e-003	-1.205697e-002	1.32092146e-003	2.50764789e-006	0.5047	26
061	1	1.00884127e-002	-2.074392e-002	1.15050276e-003	4.49796300e-006	0.9244	25
060	1	4.34177327e-003	8.413468e-003	1.31569749e-003	-2.73605743e-006	1.0060	26
059	1	1.16003831e-003	-2.011026e-003	1.92968027e-003	3.80299211e-006	0.7332	25
X18	1	5.36886273e-003	-6.214541e-003	1.45261837e-003	2.25518592e-006	0.6637	28
056	1	1.80161432e-002	-2.068603e-002	-3.72581169e-004	-3.80431070e-007	1.3363	28
055	1	7.28194471e-003	1.453630e-003	9.52421315e-004	-1.86558914e-006	0.9417	28
054	1	1.34960001e-002	-1.388723e-002	8.36348987e-004	-1.31052250e-007	0.6511	26
053	1	1.00680155e-002	-8.060877e-003	1.15128733e-003	3.12893901e-007	0.6401	28
052	1	1.60378839e-002	-1.943119e-002	5.81110578e-004	3.67969435e-007	0.4389	28
051	1	1.96401386e-002	-3.387229e-002	2.37542095e-004	3.93319368e-006	0.6208	29
050	1	1.10244510e-002	-1.776897e-002	1.07591263e-003	4.19968241e-006	0.5021	23
049	1	1.37580325e-002	-1.688490e-002	7.50700948e-004	7.25174589e-007	0.4526	28
048	1	4.21626501e-003	7.039748e-003	1.45828931e-003	-2.78845820e-006	1.3134	28
047	1	1.19684791e-002	-3.674009e-003	4.71270943e-004	-2.79621313e-006	0.5761	29
046	1	1.16803277e-002	-9.865014e-003	8.26541140e-004	-3.05238682e-007	0.8536	26
045	1	2.96906980e-003	1.316666e-002	1.56583699e-003	-3.96086670e-006	0.9888	27
044	2	1.39257539e-002	-1.485845e-002	7.57731383e-004	1.27989904e-007	0.6508	28
043	1	1.17536989e-002	-2.273718e-002	1.23339630e-003	5.88797024e-006	0.5036	23
042	1	1.54655244e-002	-2.276579e-002	4.51193169e-004	1.80637423e-006	0.7682	31
041	1	-1.25788572e-003	1.372234e-002	2.85039072e-003	-1.00162249e-006	0.7456	27
040	1	2.00944031e-002	-3.254338e-002	3.10536254e-004	3.27020593e-006	0.6612	25
039	1	2.08580441e-002	-3.136754e-002	1.59401060e-004	2.43423257e-006	1.0773	27
038	1	6.64215269e-003	2.297505e-003	1.26911449e-003	-1.86946987e-006	0.9411	26
037	1	2.85323179e-002	-3.715319e-002	-9.30202501e-004	9.32867192e-008	0.8750	27
036	1	1.16317264e-002	-7.820167e-003	9.15187336e-004	-1.17852891e-006	1.2289	50
X19	1	(grouped with 036_1)					
034	1	8.95215938e-003	-7.590728e-003	1.18567895e-003	2.59452772e-007	1.1124	55
033	1	(grouped with 034_1)					
032	1	2.38439155e-002	-3.346548e-002	-5.10602019e-004	1.47333953e-006	1.1909	28
031	1	1.63175724e-002	-1.466377e-002	4.62483980e-004	-1.47116988e-006	1.3595	29
030	1	1.46143667e-002	-1.323884e-002	7.36158672e-004	-4.14895511e-007	1.2963	56
029	1	(grouped with 030_1)					
028	1	3.42341110e-002	-4.172630e-002	-1.52121804e-003	-1.14299593e-006	1.7616	27
027	1	1.95720258e-002	-2.601583e-002	1.31962391e-004	1.36705148e-006	2.4139	57
026	1	(grouped with 027_1)					
025	1	2.01451779e-003	8.728897e-003	2.06449860e-003	-1.64137362e-006	1.4384	28
024	1	2.35844381e-002	-3.274074e-002	-4.00403360e-004	1.47364928e-006	2.5723	29
023	1	5.87619565e-003	-8.046247e-003	1.79860830e-003	3.02774552e-006	1.0755	24
022	1	-2.44953424e-003	6.234976e-003	2.72784324e-003	3.17453867e-006	2.0046	26
021	1	1.41028892e-003	4.466761e-003	1.95022506e-003	1.09382219e-006	2.5842	29
020	1	1.97227794e-002	-2.456271e-002	1.58722559e-004	1.52734238e-006	2.5708	27
019	1	1.32212009e-002	-1.617882e-002	8.69539066e-004	1.66235937e-006	1.1578	55
018	1	(grouped with 019_1)					
017	1	2.07804045e-002	-2.047416e-002	1.65884421e-004	-9.27506981e-007	1.1217	30
016	1	7.74830842e-003	-1.674730e-003	1.23603255e-003	-9.36544303e-007	1.2977	29
015	1	2.31298922e-002	-2.461991e-002	-8.17213748e-004	-6.05252479e-007	1.0854	29
014	1	1.86895576e-002	-1.858824e-002	3.78966116e-004	-4.02108471e-007	1.3674	30
013	1	1.83186106e-002	-1.426752e-002	6.20149126e-004	-2.53211715e-006	1.2964	29
012	1	2.51052836e-002	-2.527728e-002	-6.42565782e-004	-1.04879622e-006	1.2292	31
011	1	1.74778447e-002	-1.559639e-002	5.43633136e-004	-8.67071178e-007	1.2646	89
010	1	1.63077298e-002	-1.105469e-				

Table 3.1.13. Same as Table 3.1.11, but for leg 4.

STN	CAST	dSOC	doffset	dTCor	dPCor	ADEV	NUM
622	1	1.19460307e-002	-1.238833e-002	1.23972220e-003	1.73074430e-007	0.6496	70
623	1	(grouped with 622_1)					
624	1	(grouped with 622_1)					
625	1	(grouped with 622_1)					
626	1	(grouped with 622_1)					
627	1	(grouped with 622_1)					
628	1	8.08956689e-003	-6.220221e-003	1.61355750e-003	2.97165215e-006	0.4276	20
629	1	1.23927280e-002	-1.275307e-002	1.11852434e-003	7.94633571e-007	0.3864	22
630	1	1.21865078e-002	-1.740439e-002	1.28209318e-003	1.56388565e-006	0.6582	21
631	1	1.22695064e-002	-1.590750e-002	1.12142000e-003	1.36664664e-006	0.5053	23
632	1	1.53017807e-002	-1.521908e-002	7.33845636e-004	-1.91470701e-006	0.4659	23
001	1	1.63703046e-002	-2.475552e-002	9.99122316e-004	-3.56449492e-008	0.5506	27
002	1	1.57347664e-002	-1.353171e-002	5.88736034e-004	-1.94079587e-006	0.9337	27
003	1	1.49867601e-002	-3.334577e-002	1.57269811e-003	4.34600767e-006	0.6673	29
004	1	1.46189162e-002	-1.359686e-002	8.75802415e-004	-2.00882142e-006	0.3686	28
005	1	1.21119088e-002	-1.352664e-002	1.18380675e-003	-2.05495950e-007	0.6281	29
006	1	1.26743087e-002	-1.149839e-002	1.11494816e-003	-6.92780764e-007	0.4888	28
007	1	1.14939891e-002	-7.198705e-003	1.04079914e-003	-1.26835223e-006	0.5054	28
008	1	1.66534716e-002	-2.525800e-002	1.04490982e-003	-2.66597826e-007	0.6440	26
009	1	1.87968469e-002	-2.665526e-002	7.00893586e-004	-9.46484074e-007	0.4262	25
010	1	7.08772760e-003	1.015941e-002	1.36572486e-003	-2.62669973e-006	1.0179	28
011	1	8.09877281e-003	5.892469e-003	1.15118709e-003	-1.90882487e-006	0.7568	33
X17	1	9.45648936e-003	-2.910608e-003	1.35514436e-003	-7.03116325e-007	0.6818	30
013	1	1.19036751e-002	-1.479927e-003	9.16114463e-004	-2.66366816e-006	0.7239	28
014	1	5.81682828e-003	1.651614e-003	1.68721291e-003	5.36373565e-007	0.7090	28
015	1	2.49255576e-002	-4.325531e-002	3.25798890e-004	-3.37942498e-007	0.4482	26
016	1	1.35354445e-002	-2.215709e-002	1.33053965e-003	2.84850971e-006	0.6458	21
X23	1	6.16378653e-003	4.118997e-003	1.77776819e-003	9.18330187e-007	0.3706	20
018	1	6.83222393e-003	-2.974464e-003	1.80392870e-003	3.25458203e-006	0.7454	55
019	1	(grouped with 018_1)					
020	1	(grouped with 018_1)					
021	1	1.53295265e-002	-2.115045e-002	9.91540826e-004	1.58346555e-006	0.4492	22
022	1	9.61716512e-003	-1.336717e-002	2.02569844e-003	4.79303555e-006	0.8348	19
023	1	1.08247842e-002	-9.317714e-003	1.34021413e-003	7.47641272e-007	0.2895	18
024	1	1.54278469e-002	-2.947011e-002	1.13529779e-003	6.28646063e-006	0.3530	17
025	1	1.20151338e-002	-1.569901e-002	1.33615489e-003	2.92576256e-006	0.4120	20
026	1	2.15863387e-002	-3.331918e-002	4.63559933e-004	1.68714349e-007	0.7305	25
027	1	1.24698089e-002	-1.484383e-002	1.16944869e-003	8.08998097e-007	0.7570	26
028	1	2.15012608e-002	-3.082625e-002	4.78759683e-004	-1.08134842e-006	0.3289	27
029	1	1.61358969e-002	-2.224921e-002	1.01879151e-003	8.14005621e-008	0.5804	27
030	1	1.77462765e-002	-2.794173e-002	8.40465409e-004	9.73978731e-007	0.5118	28
031	1	1.84583618e-002	-3.053622e-002	1.03220689e-003	9.45114250e-007	0.3815	28
032	1	1.33639632e-002	-7.363043e-003	9.45374770e-004	-1.58462344e-006	0.6724	28
033	1	1.22656543e-002	-1.810905e-003	9.79904388e-004	-1.86250880e-006	1.0447	27
034	1	1.21025499e-002	2.668724e-003	9.45282016e-004	-2.34251481e-006	0.5943	20
035	1	8.98603652e-003	6.972679e-003	1.55623427e-003	-1.32894216e-006	0.8113	26
036	1	1.64209820e-002	-1.440089e-002	9.60325914e-004	-9.76379458e-007	0.9917	27
037	1	1.23192885e-002	-5.910177e-003	1.43848556e-003	-1.03444371e-006	0.6851	32
038	1	1.32601640e-002	-1.006011e-002	1.36780509e-003	-2.35621543e-007	0.4556	35
039	1	1.40252661e-002	-1.451711e-002	1.33708899e-003	4.11380674e-007	0.6692	29
X16	1	1.17639342e-002	4.149995e-003	1.05158481e-003	-2.99660726e-006	0.9274	31
041	1	1.26145984e-002	-6.655124e-003	1.30215365e-003	-7.00108237e-007	0.4527	31
042	1	1.31273290e-002	-3.172715e-003	1.25977204e-003	-1.60632591e-006	0.9332	30
043	1	1.47413015e-002	-5.812054e-003	9.77066402e-004	-2.18787118e-006	0.5921	32
044	1	1.51597126e-002	-8.448579e-003	7.72679750e-004	-1.34047938e-006	0.6151	32
045	1	1.45679702e-002	-9.658047e-003	1.07929015e-003	-6.12702663e-007	0.4844	31
046	1	1.66700040e-002	-1.127564e-002	8.62028680e-004	-1.50712201e-006	0.5236	31
X15	1	1.21696205e-002	-2.160569e-003	1.40832484e-003	-1.66002472e-006	0.4344	32
048	1	1.76950237e-002	-1.676019e-002	9.55459209e-004	-6.73610749e-007	0.5064	29
049	1	1.58802632e-002	-8.291853e-003	8.37587663e-004	-1.92014630e-006	0.5884	55
050	1	(grouped with 049_1)					
051	1	2.50538097e-002	-3.394725e-002	3.38584953e-004	-9.45196059e-007	0.6024	27
052	1	2.50079573e-002	-3.840986e-002	8.63142023e-004	7.97451532e-007	0.5092	25
053	1	1.95501389e-002	-1.639460e-002	8.85447428e-004	-1.53289655e-006	0.5314	29
054	1	2.15437389e-002	-2.237765e-002	5.18226273e-004	-9.24638943e-007	0.4029	22
055	1	1.54200792e-002	-8.205450e-003	1.10988866e-003	-1.75089544e-006	0.5035	72
056	1	(grouped with 055_1)					
057	1	(grouped with 055_1)					
058	1	3.03345901e-002	-4.907400e-002	1.14779507e-004	3.80617180e-008	0.5185	54
059	1	(grouped with 058_1)					
060	1	2.15018503e-002	-2.848844e-002	8.05592347e-004	-1.85852402e-007	0.6939	27
061	1	1.76551818e-002	-1.492066e-002	9.11079057e-004	-1.65918456e-006	0.5173	28
X14	1	1.95987008e-002	-2.052938e-002	1.02583629e-003	-1.10269771e-006	0.7835	29
063	1	1.80746085e-002	-1.511890e-002	8.68231648e-004	-1.59755872e-006	0.8123	28
064	1	2.91936029e-002	-4.859550e-002	2.12192251e-004	7.73721323e-007	0.7360	29
065	1	1.71586901e-002	-1.086844e-002	9.93254092e-004	-2.57375867e-006	0.4127	32
066	1	2.12719174e-002	-1.707289e-002	2.91449105e-004	-2.74589444e-006	0.6316	30
067	1	1.98544820e-002	-1.009702e-002	2.95178264e-004	-3.77050125e-006	0.5261	31
068	1	1.99380500e-002	-1.325896e-002	5.52925286e-004	-2.88075045e-006	0.6975	28
069	1	2.39454326e-002	-3.353565e-002	7.53322993e-004	-4.46688515e-007	0.7946	31
070	1	1.89640275e-002	-1.158135e-002	6.43918978e-004	-2.85252549e-006	1.0858	30
071	1	2.33875867e-002	-2.660745e-002	3.79954793e-004	-1.18208558e-006	1.0062	30
072	1	1.67774431e-002	-2.134682e-003	6.49432437e-004	-4.08231549e-006	0.8040	32
073	1	2.35503690e-002	-2.969429e-002	3.29612428e-004	-1.00313106e-006	0.5985	29
074	1	1.88295466e-002	-3.338946e-002	1.24004326e-003	3.36388360e-006	0.6702	25
075	1	2.25811536e-002	-3.156603e-002	6.29669927e-004	8.38036877e-009	0.8971	28
076	1	3.07743878e-002	-5.218067e-002	1.94753168e-004	8.57265544e-007	0.6289	27
077	1	9.65008917e-003	2.863497e-003	9.54057446e-004	-7.59163286e-008	0.9108	23
078	1	1.76187174e-002	-1.193663e-002	7.42492887e-004	-2.03486649e-006	0.9003	28
079	1	1.61850649e-002	-1.706836e-002	8.64550489e-004	2.59055814e-007	1.1742	32
080	1	1.32468143e-002	-9.204188e-003	1.36956379e-003	-1.09447089e-007	0.7653	29
081	1	1.56201792e-002	-1.334751e-002	1.01720967e-003	-3.77589331e-007	0.9621	32
082	1	1.65487991e-002	-1.142550e-002	7.70429133e-004	-1.17118285e-006	0.9250	33
083	1	1.10998663e-002	1.475583e-002	8.86634351e-004	-5.45472046e-006	0.8739	30
084	1	1.43930715e-002	-2.139139e-002	1.49544719e-003	2.54010078e-006	1.0532	32
085	1	1.42946636e-002	1.378177e-003	8.31565051e-004	-3.60640617e-006	0.9981	34
086	1	1.33151051e-002	6.753291e-003	1.02322280e-003	-4.46082654e-006	3.7508	31
087	1	1.36777457e-002	-2.723718e-003	1.16024137e-003	-1.95332943e-006	1.9374	33
X13	1	8.43106107e-003	2.192290e-002	1.23873579e-003	-5.94444250e-006	0.8429	33
089	2	1.76864488e-002	-1.843653e-002	1.01115059e-003	-8.02266851e-007	0.8694	30
090	1	1.70316790e-002	-9.748997e-003	6.1637426e-004	-2.53025527e-006	0.7475	28
091	1	2.38612552e-002	-3.208860e-002	6.85820669e-004	-6.84203394e-007	1.2473	29
092	1	2.21868941e-002	-2.240719e-002	1.66571357e-004	-2.23781863e-006	1.7122	26
093	1	2.08670181e-002	-2.619265e-002	4.61822749e-004	-4.54456988e-007	1.9235	52
094	1	(grouped with 093_1)					
095	1	2.64634247e-002	-3.655167e-002	1.33632464e-004	-1.58701618e-006	0.6288	24
096	1	1.07604073e-002	-5.553448e-004	1.15924505e-003	1.36311468e-006	2.3242	54
097	1	(grouped with 096_1)					
098	1	(grouped with 096_1)					
099	1	(grouped with 096_1)					
100	1	(grouped with 096_1)					

Table 3.1.14. Same as Table 3.1.11, but for leg 5.

STN	CAST	dSOC	doffset	dTCor	dPCor	ADEV	NUM						
610	1	1.20733575e-002	-2.356255e-002	1.63218378e-003	9.83774066e-006	2.1660	67						
609	1	(grouped with 610_1)											
608	1	(grouped with 610_1)											
607	1	(grouped with 610_1)											
606	1	(grouped with 610_1)											
605	1	(grouped with 610_1)											
604	1	2.26872987e-002	-3.475949e-002	5.91361349e-004	5.63393254e-006	1.7576	41						
603	1	(grouped with 604_1)											
602	1	-6.86448944e-004	-3.933016e-003	2.56103293e-003	1.40847510e-005	0.9603	20						
601	1	1.87935719e-002	-2.095474e-002	9.22658094e-004	1.45803290e-006	1.9468	24						
600	1	1.92819046e-003	3.357785e-002	1.76702373e-003	-4.36132975e-006	0.9974	26						
599	1	-5.46730002e-003	5.204253e-002	1.78975989e-003	-3.95628613e-006	3.0401	22						
598	1	2.03488348e-002	-2.088571e-002	4.66454603e-004	2.63106480e-007	2.0001	80						
597	1	(grouped with 598_1)											
596	1	(grouped with 598_1)											
595	1	1.59338416e-002	-1.851902e-002	7.02688756e-004	2.27013493e-006	2.2699	26						
594	1	1.83132706e-002	-1.226940e-002	2.40686026e-004	-1.15502189e-006	1.5586	25						
593	1	2.36860164e-002	-3.387828e-002	2.34852141e-004	1.96119010e-006	0.9235	28						
592	1	2.17850196e-002	-2.491920e-002	2.185082514e-004	9.59659422e-007	1.4176	55						
591	1	(grouped with 592_1)											
590	1	5.78591338e-003	1.049697e-002	1.07738238e-003	2.70964561e-009	2.3647	25						
589	1	2.20929963e-002	-3.663022e-002	4.77204922e-004	3.65165964e-006	1.6937	55						
588	1	(grouped with 589_1)											
587	1	4.69595550e-003	-2.547314e-004	1.69228873e-003	4.33360893e-006	1.3863	59						
586	1	(grouped with 587_1)											
585	1	(grouped with 587_1)											
584	1	8.94782046e-003	-9.538858e-003	1.29144265e-003	2.94523759e-006	1.8189	67						
583	1	(grouped with 584_1)											
582	1	(grouped with 584_1)											
581	1	(grouped with 584_1)											
580	1	(grouped with 584_1)											
579	1	(grouped with 584_1)											
578	1	1.28631166e-002	-1.837581e-002	8.50089454e-004	3.77456639e-006	0.8449	27						
577	1	1.27680634e-002	-1.387040e-002	9.41950733e-004	2.62307342e-006	0.6177	31						
576	1	1.44702524e-002	-1.522080e-002	7.71926880e-004	1.74817211e-006	0.9905	31						
575	1	1.45267653e-002	-1.491045e-002	8.89060867e-004	1.55864623e-006	0.8382	32						
574	1	1.65097376e-002	-2.022990e-002	8.21704365e-004	2.60498057e-006	0.6716	31						
573	1	2.15052072e-002	-2.778208e-002	2.89823408e-004	1.95590704e-006	0.8638	32						
572	1	2.23312523e-002	-3.213603e-002	2.13366671e-004	2.91994727e-006	1.3416	32						
571	1	9.26503010e-003	-3.337131e-003	9.22094847e-004	8.25085694e-007	1.0847	32						
570	1	1.40516165e-002	-1.413590e-002	7.02786187e-004	2.00289810e-006	1.9510	32						
569	1	2.26653312e-002	-3.160432e-002	2.34834551e-004	2.66451443e-006	0.8366	32						
X07	1	1.40393950e-002	-1.568025e-002	1.02348083e-003	2.36932115e-006	0.8593	32						
567	1	1.44264524e-002	-1.483491e-002	7.34582917e-004	1.90049881e-006	1.2330	28						
566	1	1.57136503e-002	-2.288942e-002	8.29120894e-004	3.68924908e-006	0.9175	60						
565	1	1.22962466e-002	-1.118712e-002	8.29120894e-004	2.07144221e-006	1.1151	60						
564	1	5.78415032e-003	-2.928588e-004	1.27863101e-003	2.11437298e-006	1.4338	30						
563	1	1.52193485e-002	-1.955116e-002	8.27753220e-004	3.06487731e-006	2.0633	31						
562	1	1.08762747e-002	-7.646221e-003	9.72237017e-004	1.24285159e-006	2.0368	26						
561	1	1.15954715e-002	-1.602106e-002	1.04204522e-003	4.93711638e-006	1.3834	59						
560	1	(grouped with 561_1)											
559	1	(grouped with 561_1)											
558	1	1.29136221e-002	-2.559967e-002	9.75662261e-004	8.48647023e-006	1.1207	22						
557	1	1.70985806e-002	-2.857047e-002	6.04636421e-004	4.23044587e-006	1.5239	31						
556	1	6.26128039e-003	5.594300e-003	1.07682114e-003	-3.47522296e-007	1.1130	30						
555	1	1.57537667e-002	-2.557984e-002	5.79980689e-004	4.31517410e-006	1.5601	33						
554	1	1.79850222e-002	-3.209968e-002	6.87246500e-004	5.28446924e-006	1.6509	29						
553	1	2.21324398e-002	-3.771872e-002	3.40806879e-004	4.82790470e-006	1.0153	28						
552	1	5.32308758e-003	1.657021e-003	1.39162661e-003	1.54656822e-006	1.3700	26						
551	1	1.50355983e-002	-9.705487e-003	1.05640760e-003	-6.74130677e-007	1.2476	50						
550	1	1.16863387e-002	-1.847372e-002	1.05640760e-003	5.30808172e-006	1.2939	50						
549	1	1.66950775e-002	-1.861653e-002	4.53355320e-004	1.24461964e-006	0.9021	27						
548	1	-3.04226705e-003	2.716174e-002	1.90480253e-003	-1.70107779e-006	1.5513	48						
547	1	3.27018603e-003	-1.269075e-002	1.90480253e-003	8.43831908e-006	1.4882	48						
546	1	1.15908782e-002	-1.787599e-002	9.20205984e-004	4.96445747e-006	0.4229	23						
545	1	1.67927497e-002	-1.963366e-002	4.92743902e-004	1.26334442e-006	0.7109	25						
544	1	1.16500091e-002	-1.647379e-002	9.85577218e-004	5.14476124e-006	1.0911	65						
543	1	(grouped with 544_1)											
542	1	(grouped with 544_1)											
541	1	1.04742811e-002	-5.654989e-003	7.07803941e-004	-1.54587022e-006	0.5859	22						
540	1	9.25994936e-003	-2.037964e-003	1.07477067e-003	4.54406383e-007	1.0096	24						
539	1	5.98836558e-003	-3.283487e-003	1.38163824e-003	5.33520381e-006	0.7880	23						
538	1	1.20558840e-002	-2.630609e-002	9.95838992e-004	9.87556498e-006	0.8110	22						
537	1	7.68910592e-003	-8.638711e-003	1.22004509e-003	4.80930438e-006	1.4739	26						
536	1	2.63683334e-002	-4.938961e-002	2.66292527e-004	6.32455119e-006	1.3326	26						
535	1	1.29855564e-002	-1.122212e-002	7.93212419e-004	1.17103633e-006	1.1375	52						
534	1	1.19759719e-002	-2.150073e-002	7.93212419e-004	5.95530280e-006	1.1821	52						
533	1	1.80191449e-002	-3.013670e-002	5.53073597e-004	4.17396356e-006	1.4089	30						
532	1	2.04048826e-002	-4.185628e-002	6.83170929e-004	6.86633280e-006	0.9317	27						
531	1	1.71072949e-002	-1.863332e-002	4.69457008e-004	7.74440534e-007	0.9950	58						
530	1	(grouped with 531_1)											
529	1	(grouped with 531_1)											
528	1	(grouped with 531_1)											
527	1	(grouped with 531_1)											
526	1	(grouped with 531_1)											
525	1	(grouped with 531_1)											
524	1	(grouped with 531_1)											
523	1	(grouped with 531_1)											
522	1	(grouped with 531_1)											
521	1	(grouped with 531_1)											
520	1	(grouped with 531_1)											
519	1	(grouped with 531_1)											
518	1	(grouped with 531_1)											
517	1	(grouped with 531_1)											
516	1	(grouped with 531_1)											
515	1	(grouped with 531_1)											
514	1	(grouped with 531_1)											
513	1	(grouped with 531_1)											
512	1	(grouped with 531_1)											
511	1	(grouped with 531_1)											
510	1	(grouped with 531_1)											
509	1	1.65355694e-002	-1.577446e-002	4.45665283e-004	5.28626655e-009	0.9374	62						
508	1	(grouped with 509_1)											
507	1	2.20386557e-002	-3.539696e-002	3.36933455e-004	3.49846270e-006	0.6331	33						
506	1	1.80924612e-002	-2.378328e-002	5.40986585e-004	1.79867344e-006	0.6165	32						
505	1	1.73962430e-002	-1.698524e-002	3.49645469e-004	3.84005411e-008	1.1031	96						
504	1	1.77261161e-002	-1.548565e-002	3.49645469e-004	-3.11724107e-007	1.6332	96		</				

References

Budeus, G. and W. Schneider (1998): In-situ temperature calibration: A remark on instruments and methods, *Intl. WOCE Newsletter*, 30, 16-18.

Lagarias, J.C., J.A. Reeds, M.H. Wright and P. E. Wright (1998): Convergence properties of the Nelder-Mead simplex method in low dimensions, *SIAM Journal of Optimization*, 9, 112-147.

Larson, N. and A. Pederson (1996): Temperature measurements in flowing water: Viscous heating of sensor tips, 1st IGHEM Meeting, Montreal, Canada.

(http://www.seabird.com/technical_references/paperindex.htm)

3.2 Salinity

8 February 2005

(1) Personnel

Takeshi Kawano (JAMSTEC)

Takeo Matsumoto (MWJ)

Naoko Takahashi (MWJ)

Tomomi Watanabe (Nagasaki University)

(2) Objectives

Bottle salinities were measured in order to be compared with CTD salinities to identify leaking bottles and calibrate CTD salinities.

(3) Instrument and Method

(3.1) Salinity Sample Collection

The bottles in which the salinity samples are collected and stored are 250 ml Phoenix brown glass bottles with screw caps. Each bottle was rinsed three times with sample water and was filled to the shoulder of the bottle. The caps were also thoroughly rinsed. Salinity samples were stored for about 24 hours in the same laboratory as the salinity measurement was made.

(3.2) Instruments and Method

The salinity analysis was carried out on two sets of Guildline Autosol salinometers model 8400B (S/N 62556 and S/N 62827), which were modified by addition of an Ocean Science International peristaltic-type sample intake pump and two Guildline platinum thermometers model 9450. One thermometer monitored an ambient temperature and the other monitored a bath temperature. The resolution of the thermometers was

0.001 °C. The measurement system was almost same as Aoyama et al (2003). The salinometer was operated in the air-conditioned ship's laboratory at a bath temperature of 24 °C. An ambient temperature varied from approximately 19 °C to 23 °C, while a bath temperature is very stable and varied within +/- 0.002 °C on rare occasion. A measure of a double conductivity ratio of a sample is taken as a median of thirty-one reading. Data collection was started after 5 seconds and it took about 10 seconds to collect 31 readings by a personal computer. Data were sampled for the sixth and seventh filling of the cell. In case the difference between the double conductivity ratio of this two fillings is smaller than 0.00003, the average value of the two double conductivity ratios was used to calculate the bottle salinity with the algorithm for practical salinity scale, 1978 (UNESCO, 1981). If the difference was greater than or equal to the 0.0003, we measured eighth filling of the cell. In case the double conductivity ratio of eighth filling did not satisfy the criteria above, we measured ninth and tenth filling of the cell and the median of the double conductivity ratios of five fillings are used to calculate the bottle salinity.

The measurement was conducted 16 hours per day (typically from noon to 04:00 in the next day in leg 1, from 17:00 to 04:00 in the next day in leg 2, from 8:00 to 24:00 in leg 4, from 7:00 to 23:00 in leg 5) and the cell was rinsed by pure water every day and cleaned by ethanol or soap or both almost every day after the measurement of the day.

(3.3) Preliminary Result

(i) Leg 1

Stand Seawater

Standardization control was set to 638 and all the measurements were done by this setting. During the whole measurement, the STANDBY was 6107 +/- 0001 and ZERO was 0.00000 to 0.00001. We used IAPSO Standard Seawater batch P142 whose conductivity ratio was 0.99991 (double conductivity ratio is 1.99982) as the standard for salinity. We measured 178 ampoules of P142 and the average of the double conductivity ratio was 1.99978 and the standard deviation was 0.000014, which is equivalent to 0.0003 in salinity. Figure 3.2.1 shows the history of double conductivity ratio of the Standard Seawater batch P142. Since there was no significant

trend in Figure 3.2.1 and the average of the double conductivity ratio was 1.99978, we add 0.00004 to all of the measured double conductivity ratio.

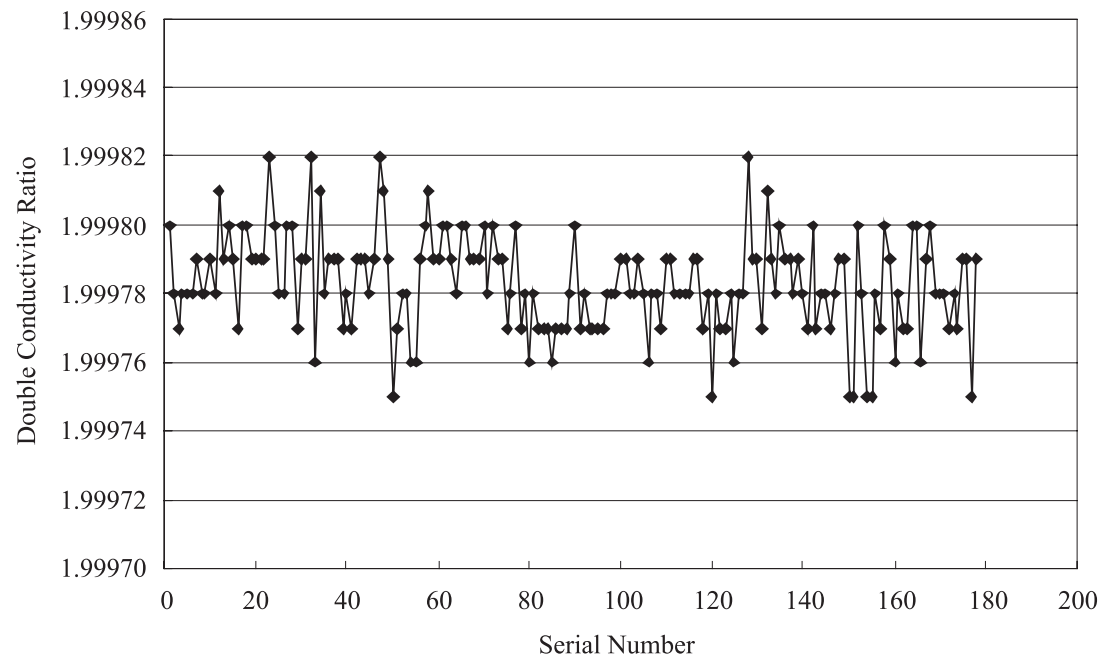

Figure 3.2.1. The history of double conductivity ratio of the Standard Seawater batch P142.

Sub-Standard Seawater

We also used sub-standard seawater which was deep-sea water filtered by pore size of 0.45 micrometer and stored in a 20 liter cubitainer made of polyethylene and stirred for at least 24 hours before measuring. It was measured every six samples in order to check the possible sudden drift of the salinometer. During the whole measurements, there was no detectable sudden drift of the salinometer.

Replicate and Duplicate Samples

We took 692 pairs of replicate and 49 pairs of duplicate samples. Figure 3.2.2 (a) and (b) shows the histogram

of the absolute difference between replicate samples and duplicate samples, respectively. There were seven bad measurements and six questionable measurements of replicate samples. As for questionable measurements, one of the pair is extremely high (more than 0.01 in salinity). This might be cause insufficient seal of the sample bottles. Excluding these bad and questionable measurements, the standard deviation of the absolute deference of 679 pairs of replicate samples was 0.0002 in salinity and that of 49 pairs of duplicate samples was 0.0003 in salinity.

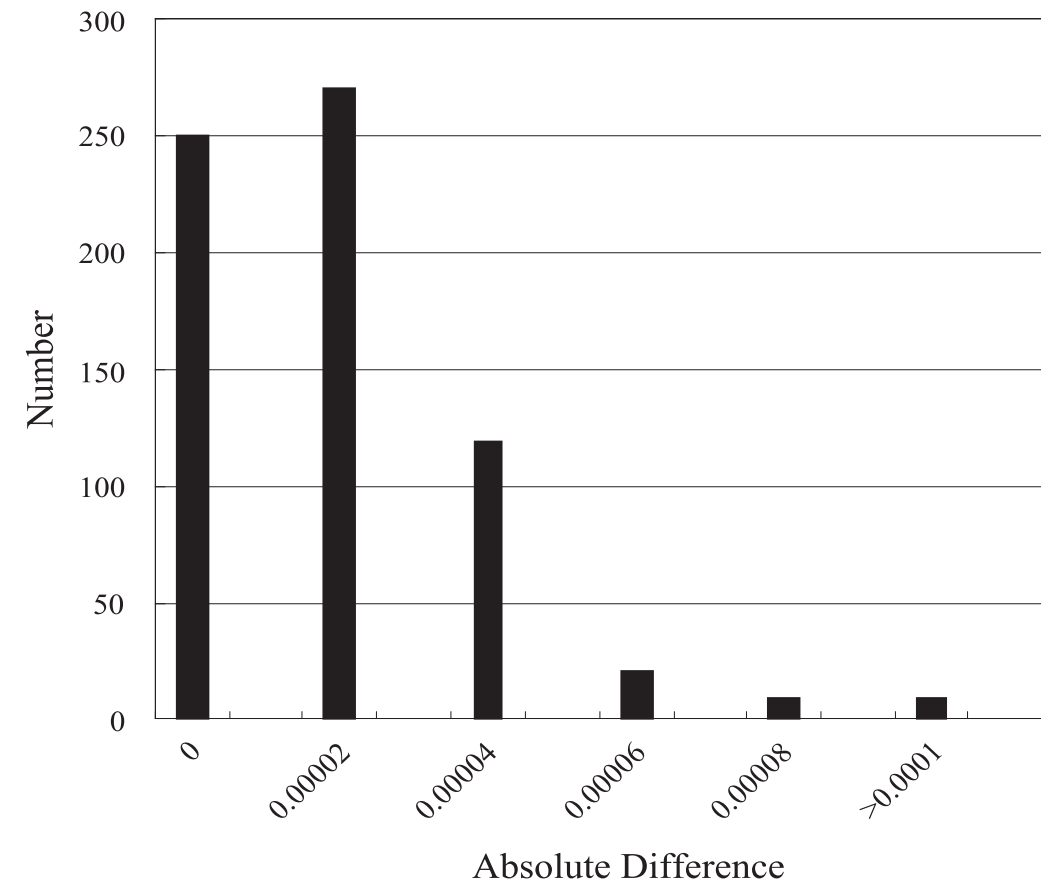

Figure 3.2.2 (a). The histogram of the absolute difference between replicate samples.

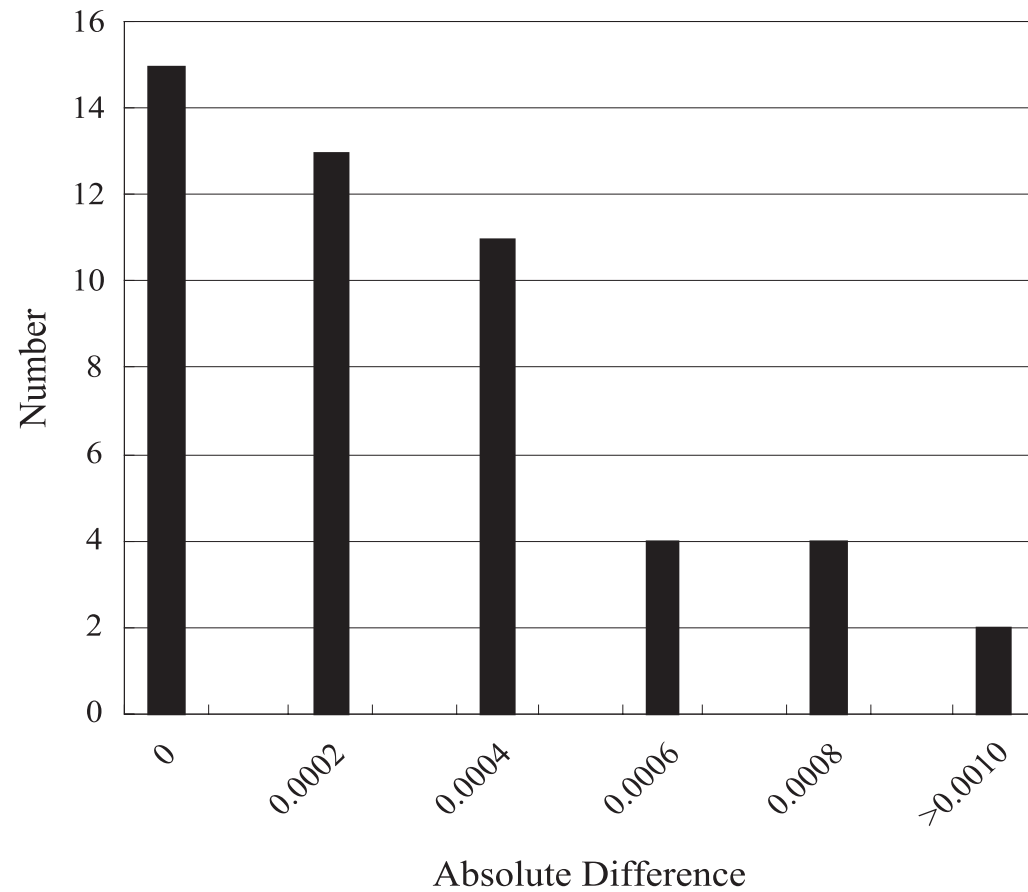

Figure 3.2.2 (b). The histogram of the absolute samples between duplicate samples.

(ii) Leg 2

Stand Seawater

Standardization control was set to 506 and all the measurements were done by this setting. During the whole measurement, the STANDBY was 6110 +/- 0001 and ZERO was -0.00001 to 0.00001. We used IAPSO Standard Seawater batch P142 which conductivity ratio was 0.99991 (double conductivity ratio is 1.99982) as the standard for salinity. We measured 157 ampoules of P142. Figure 3.2.3 shows the history of double conductivity

ratio of the Standard Seawater batch P142. The values are rather scattered during the period from the beginning to the serial number 47 (from station 127 to 95). The average of double conductivity ratio was 1.99976 and the standard deviation was 0.00018, which is equivalent to 0.0004 in salinity. We add 0.00006 to the measured double conductivity ratio during this period. As mentioned above, the cell of Autosal was removed and washed thoroughly between the serial number 47 and 48 (between station 94 and 95). The measurement system became stable after washing. The average became 1.99978 and the standard deviation became 0.00001, which is equivalent to 0.0002 in salinity. We add 0.00004 to the measured double conductivity ratio after station 94.

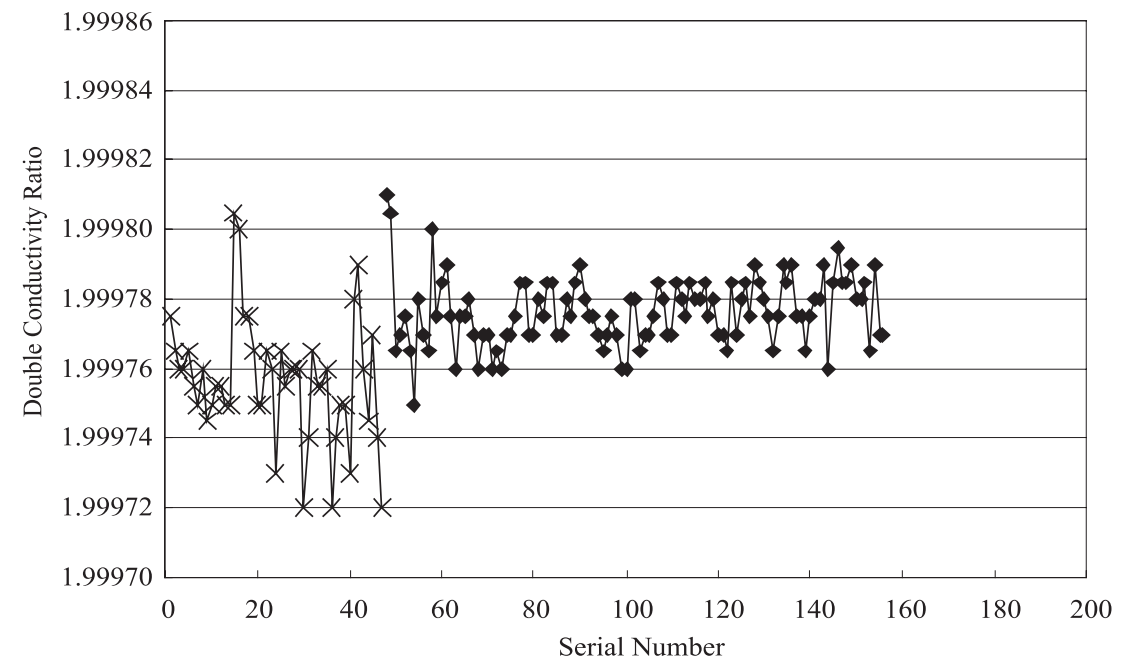

Figure 3.2.3. The history of double conductivity ratio of the Standard Seawater batch P142.

Sub-Standard Seawater

We also used sub-standard seawater which was deep-sea water filtered by pore size of 0.45 micrometer and stored in a 20 liter cubitainer made of polyethylene and stirred for at least 24 hours before measuring. It was measured every six samples in order to check the possible sudden drift of the salinometer. During the whole measurements, there was no detectable sudden drift of the salinometer.

Replicate and Duplicate Samples

We took 685 pairs of replicate and 67 pairs of duplicate samples. Figure 3.2.4 (a) and (b) shows the histogram of the absolute difference between replicate samples and duplicate samples, respectively. There were 11 bad measurements and 7 questionable measurements of replicate samples. As for questionable measurements, one of the pairs is extremely high (more than 0.01 in salinity). This might be cause insufficient seal of the sample bottles. Excluding these bad and questionable measurements, the standard deviation of the absolute deference of 667 pairs of replicate samples was 0.0002 in salinity and that of 67 pairs of duplicate samples was 0.0003 in salinity.

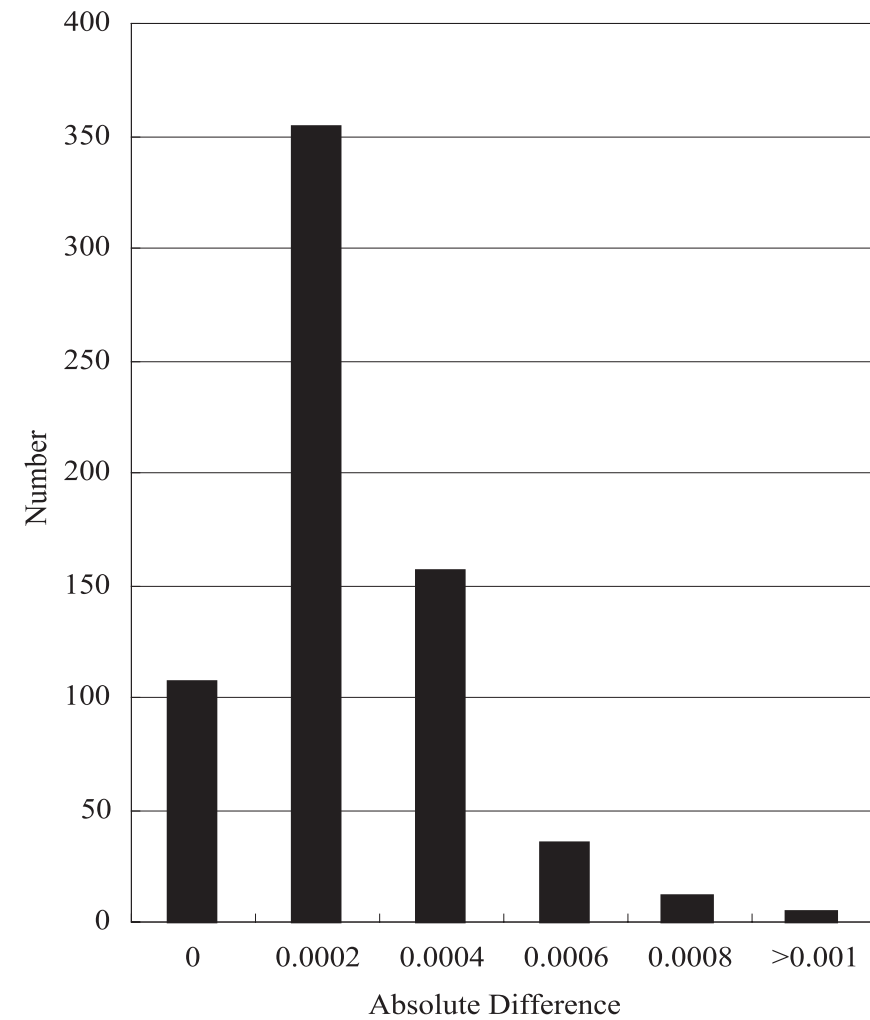

Figure 3.2.4 (a). The histogram of the absolute difference between replicate samples.

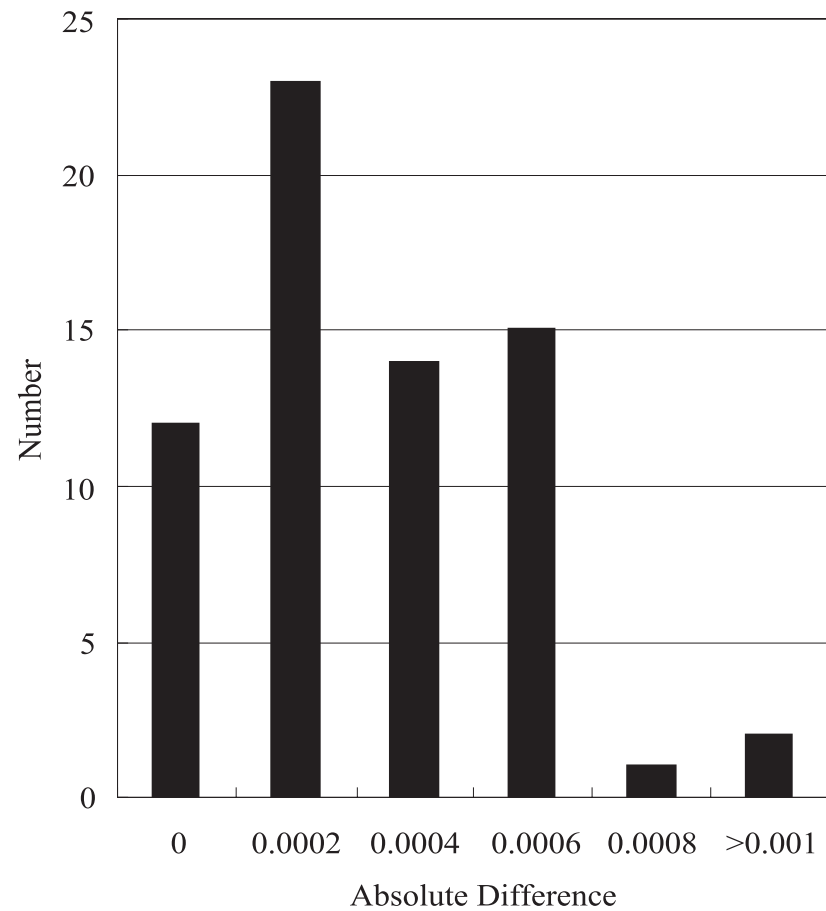

Figure 3.2.4 (b). The histogram of the absolute samples between duplicate samples.

(iii) Leg 4

Stand Seawater

Standardization control was set to 638 and all the measurements were done by this setting. During the whole measurement, the STANDBY was 6106 +/- 0001 and ZERO was 0.00000 to 0.00001. We used IAPSO Standard Seawater batch P142 whose conductivity ratio was 0.99991 (double conductivity ratio is 1.99982) as the

standard for salinity. We measured 141 ampoules of P142 and the average of the double conductivity ratio was 1.99974 and the standard deviation was 0.000009, which is equivalent to 0.0002 in salinity. Figure 3.2.5 shows the history of double conductivity ratio of the Standard Seawater batch P142. Since there was no significant trend in Figure 3.2.5 and the average of the double conductivity ratio was 1.99974, we add 0.00008 to all of the measured double conductivity ratios.

Sub-Standard Seawater

We also used sub-standard seawater which was deep-sea water filtered by pore size of 0.45 micrometer and stored in a 20 liter cubitainer made of polyethylene and stirred for at least 24 hours before measuring. It was measured every six samples in order to check the possible sudden drift of the salinometer. During the whole measurements, there was no detectable sudden drift of the salinometer.

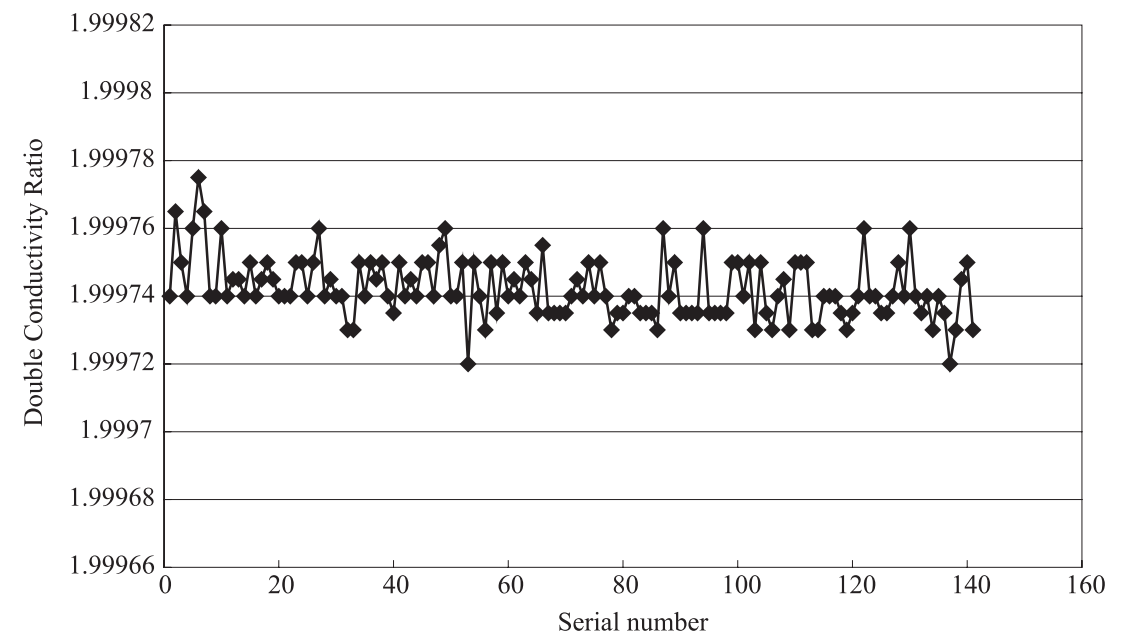

Figure 3.2.5. The history of double conductivity ratio of the Standard Seawater batch P142.

Replicate and Duplicate Samples

We took 627 pairs of replicate and 55 pairs of duplicate samples. Figure 3.2.6 (a) and (b) shows the histogram of the absolute difference between replicate samples and duplicate samples, respectively. There were one bad measurement and five questionable measurements in replicate samples and five questionable measurements in duplicate samples. As for questionable measurements, one of the pair is extremely high. This might be cause insufficient seal of the sample bottles. Excluding these bad and questionable measurements, the standard deviation of the absolute difference of 621 pairs of replicate samples was 0.0002 in salinity and that of 50 pairs of duplicate samples was 0.0003 in salinity.

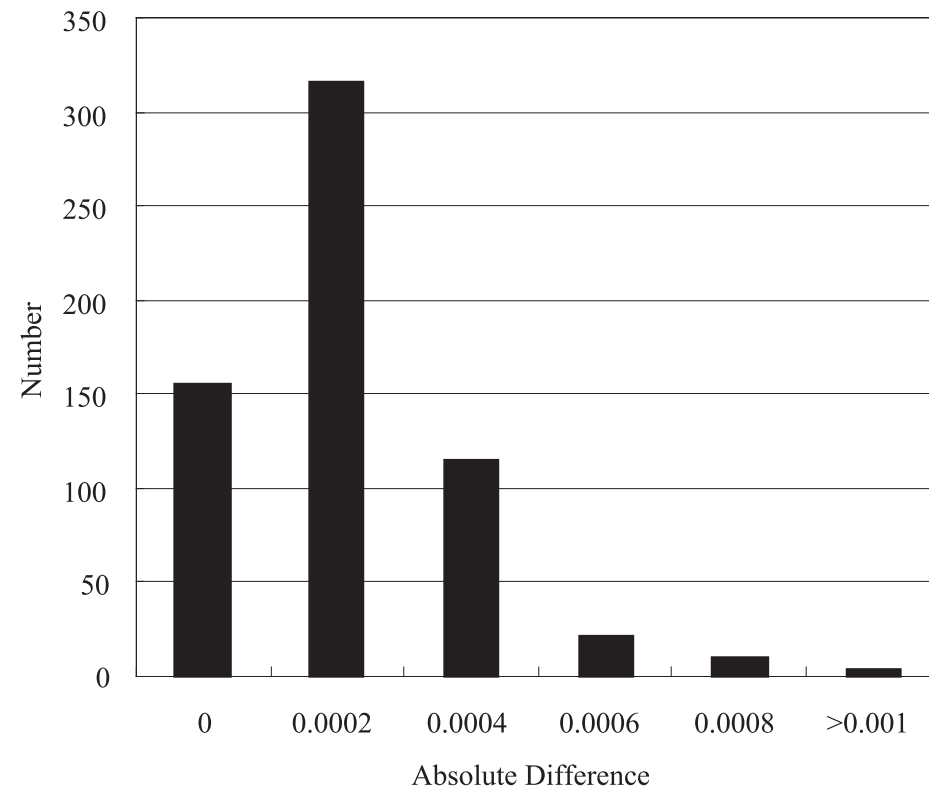

Figure 3.2.6 (a). The histogram of the absolute difference between replicate samples.

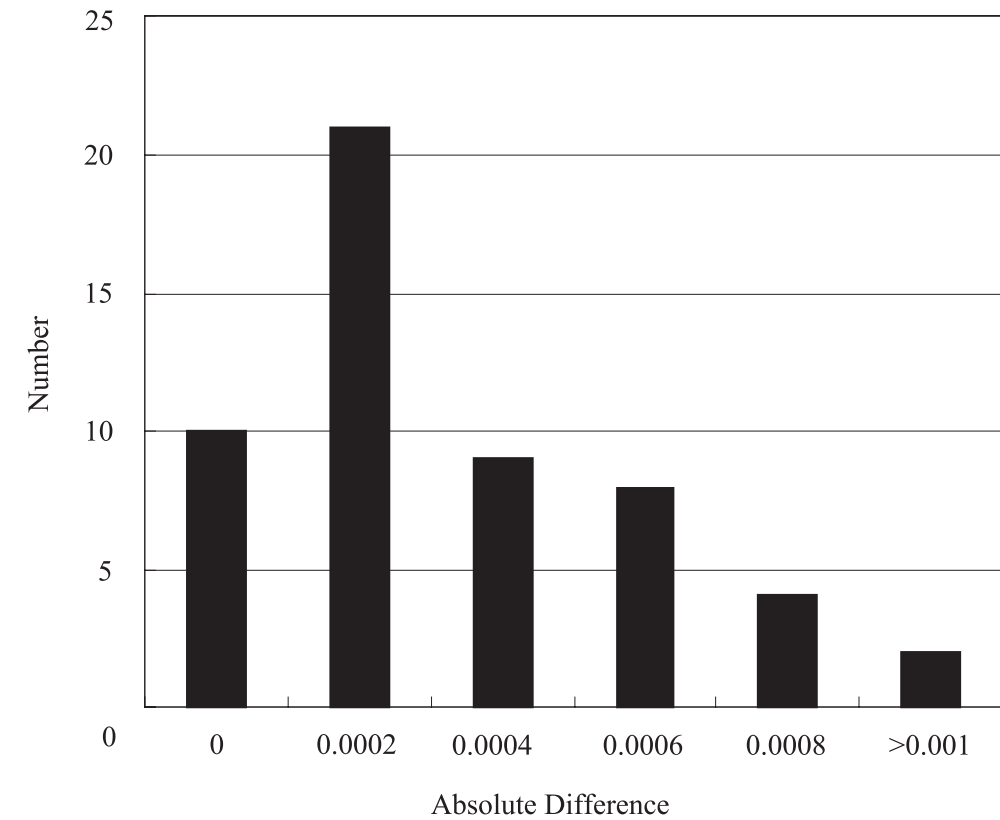

Figure 3.2.6 (b). The histogram of the absolute difference between duplicate samples.

(iv) Leg,5

Stand Seawater

Standardization control of the salinometer with serial number of 62827 and 62556 was set to 508 and 638, respectively. During the measurement, the STANDBY of 62827 was 5410 +/- 0001 and ZERO was 0.00000 to 0.00001. The STANBY of 62556 was 6107 +/- 0001 and ZERO was 0.00000 to 0.00001. We used IAPSO Standard Seawater batch P142 whose conductivity ratio was 0.99991 (double conductivity ratio is 1.99982) as the standard for salinity. We measured 194 ampoules of P142. There were 7 bad ampoules whose conductivities are

extremely high. Data of these 7 ampoules is not taken into consideration hereafter.

Figure 3.2.7 shows the history of double conductivity ratio of the Standard Seawater batch P142. The average of double conductivity ratio from Stn.610 to Stn.555 was 1.99977 and the standard deviation was 0.00008, which is equivalent to 0.0002 in salinity. We add 0.00005 to the measured double conductivity ratio during this period. The average from Stn.554 to Stn.444 was 1.99974 and the standard deviation was 0.00008. We add 0.00008 to the measured double conductivity ratio during this period.

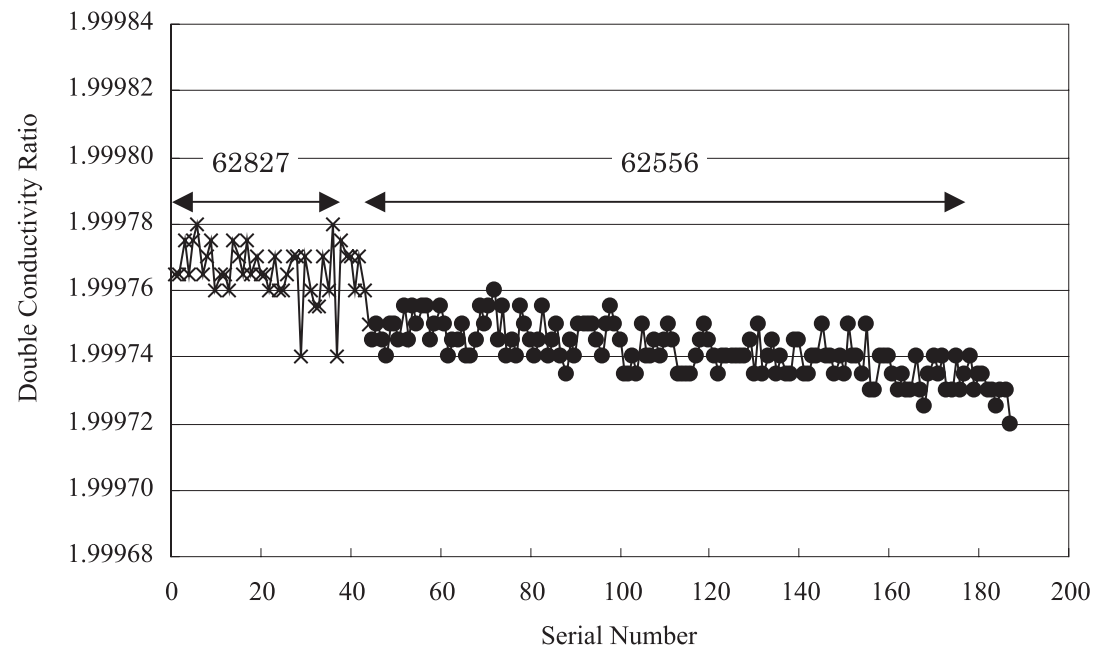

Figure 3.2.7. The history of double conductivity ratio of the Standard Seawater batch P142.

Sub-Standard Seawater

We also used sub-standard seawater which was deep-sea water filtered by pore size of 0.45 micrometer and stored in a 20 liter cubitainer made of polyethylene and stirred for at least 24 hours before measuring. It was measured every six samples in order to check the possible sudden drift of the salinometer. During the whole measurements, there was no detectable sudden drift of the salinometer.

Replicate and Duplicate Samples

We took 830 pairs of replicate and 66 pairs of duplicate samples. Figure 3.2.8 (a) and (b) shows the histogram of the absolute difference between replicate samples and duplicate samples, respectively. There were eight bad measurements and 20 questionable measurements of replicate samples and eight questionable measurements of duplicate samples. As for questionable measurements, one of the pair is extremely high (more than 0.01 in salinity). This might be cause insufficient seal of the sample bottles. Excluding these bad and questionable measurements, the standard deviation of the absolute difference of 802 pairs of replicate samples was 0.0002 in salinity and that of 58 pairs of duplicate samples was 0.0003 in salinity.

References

Aoyama, M., T. Joyce, T. Kawano and Y. Takatsuki: Standard seawater comparison up to P129.

Deep-Sea Research, I, Vol. 49, 1103~1114, 2002

UNESCO: Tenth report of the Joint Panel on Oceanographic Tables and Standards. UNESCO Tech.

Papers in Mar. Sci., 36, 25 pp., 1981

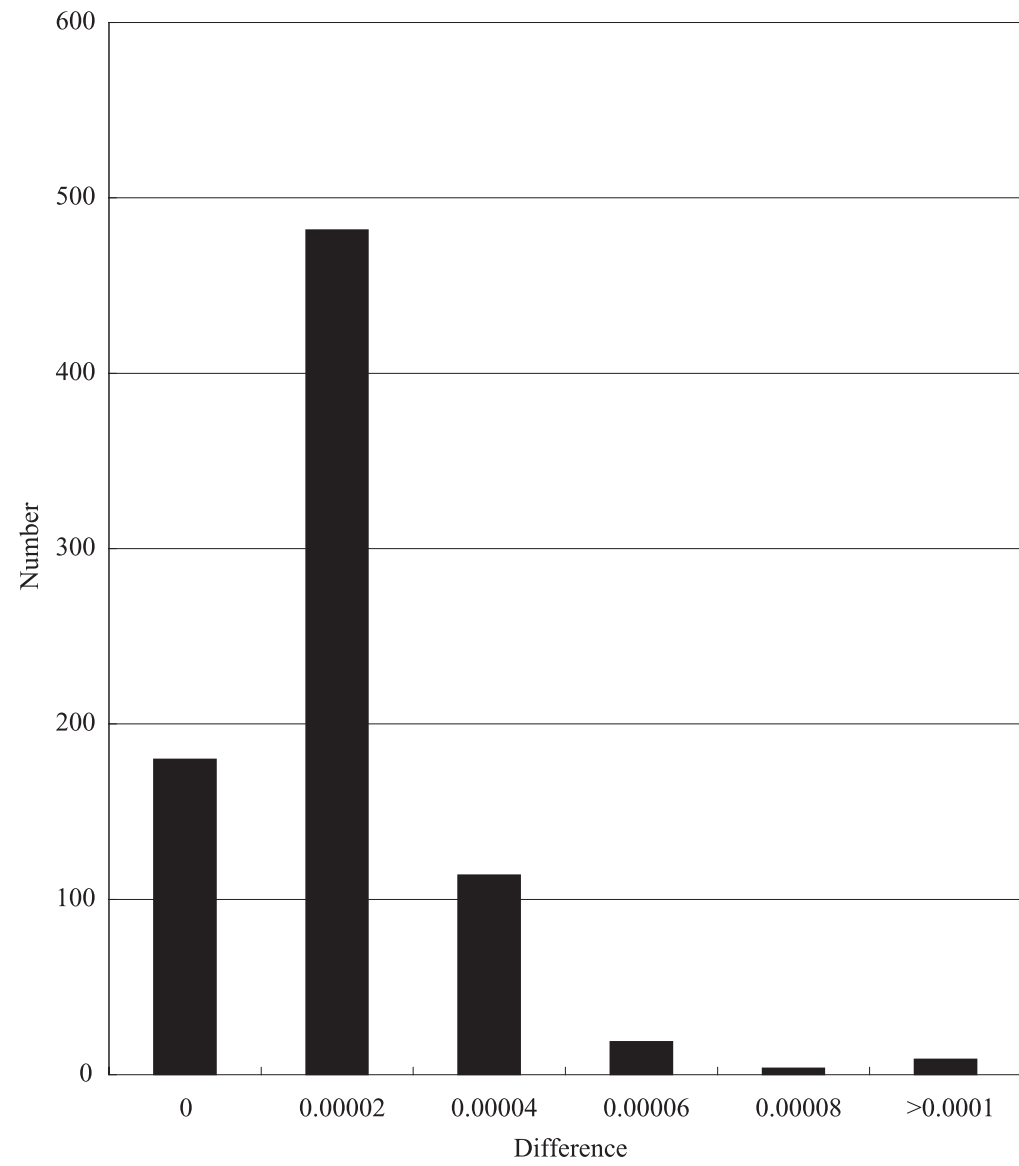

Figure 3.2.8 (a). The histogram of the absolute difference between replicate samples.

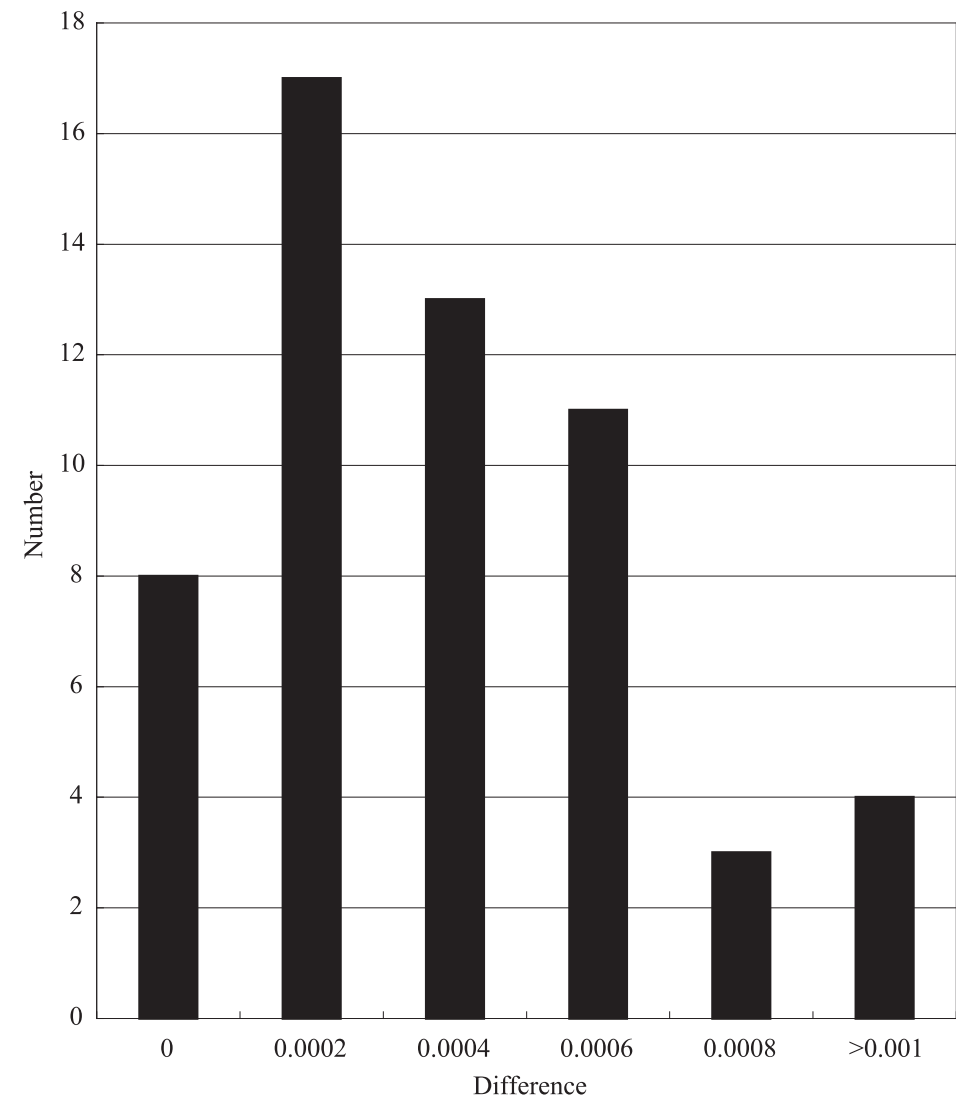

Figure 3.2.8 (b). The histogram of the absolute samples between duplicate samples.

3.3 Oxygen

28 January 2005

(1) Personnel

Yuichiro Kumamoto (JAMSTEC)

Shuichi Watanabe (JAMSTEC, Principal Investigator for leg 1, 2, 4)

Ayako Nishina (Kagoshima University, Principal Investigator for leg 5)

Kazuhiko Matsumoto (JAMSTEC)

Elisabete de Braga (Institute of Oceanography, University of Sao Paulo)

Takayoshi Seike (MWJ)

Ichiro Yamazaki (MWJ)

Tomoko Miyashita (MWJ)

Nobuharu Komai (MWJ)

(2) Objectives

Dissolved oxygen is one of the most significant tracers for the ocean circulation study. Recent studies indicated that dissolved oxygen concentration in intermediate layers changed in basin wide scale. The causes of the change, however, are still unclear. During MR03-K04, we measured dissolved oxygen concentration at all the stations along WHP P06 in the South Pacific, WHP A10 in the South Atlantic, and WHP I03 and I04 in the Indian Ocean. Our purposes are to evaluate decadal change of dissolved oxygen in the southern hemisphere.

(3) Methods

Reagents

Pickling Reagent I: Manganous chloride solution (3M)

Pickling Reagent II: Sodium hydroxide (8M) / sodium iodide solution (4M)

Sulfuric acid solution (5M)

Sodium thiosulfate (0.025M)

Potassium iodate (0.001667M)

CSK standard solution of potassium iodate: Lot TCK8677, 0.0100N,

Wako Pure Chemical Industries Ltd.

Instruments

Burette for sodium thiosulfate:

APB-510 manufactured by Kyoto Electronic Co. Ltd. / 10 cm³ of titration vessel

Burette for potassium iodate:

APB-410 manufactured by Kyoto Electronic Co. Ltd. / 20 cm³ of titration vessel

Detector and Software: Automatic photometric titrator manufactured by Kimoto Electronic Co. Ltd.

Sampling

Following procedure is based on the WHP Operations and Methods (Dickson, 1996). Seawater samples were collected with Niskin bottle attached to the CTD-system. Seawater for oxygen measurement was transferred from Niskin sampler bottle to a volume calibrated flask (ca. 100 cm³). Three times volume of the flask of seawater was overflowed. Temperature was measured by digital thermometer during the overflowing. Then two reagent solutions (Reagent I, II) of 0.5 cm³ each were added immediately into the sample flask and the stopper was inserted carefully into the flask. The sample flask was then shaken vigorously to mix the contents and to disperse the precipitate finely throughout. After the precipitate has settled at least halfway down the flask, the flask was shaken again vigorously to disperse the precipitate. The sample flasks containing pickled samples were stored in a laboratory until they were titrated.

Sample measurement

At least two hours after the re-shaking, the pickled samples were measured on board. A magnetic stirrer bar and 1 cm³ sulfuric acid solution were added into the sample flask and stirring began. Samples were titrated by sodium thiosulfate solution whose molarity was determined by potassium iodate solution. Temperature of sodium thiosulfate during titration was recorded by a digital thermometer. During this cruise we measured dissolved oxygen concentration using two sets of the titration apparatus (DOT-1 and DOT-2). Dissolved oxygen concentration ($\mu\text{mol kg}^{-1}$) was calculated by sample temperature during seawater sampling, salinity of the sample, and titrated volume of sodium thiosulfate solution.

Standardization

Concentration of sodium thiosulfate titrant (ca. 0.025M) was determined by potassium iodate solution. Pure potassium iodate was dried in an oven at 130 °C. 1.7835 g potassium iodate weighed out accurately was dissolved in deionized water and diluted to final volume of 5 dm³ in a calibrated volumetric flask (0.001667M). 10 cm³ of the standard potassium iodate solution was added to a flask using a calibrated dispenser. Then 90 cm³ of deionized water, 1 cm³ of sulfuric acid solution, and 0.5 cm³ of pickling reagent solution II and I were added into the flask in order. Amount of sodium thiosulfate titrated gave the molarity of sodium thiosulfate titrant.

Table 3.3.1, 3.3.2, 3.3.3, and 3.3.4 show result of the standardization during leg 1, 2, 4, and 5, respectively. Reproducibility (C.V.) of each standardization was less than 0.1 % (n = 5). Moreover a series of the standardizations using same sodium thiosulfate also gave errors (C.V.) less than 0.1 %.

Determination of the blank

The oxygen in the pickling reagents I (0.5 cm³) and II (0.5 cm³) was assumed to be 3.8×10^{-8} mol (Dickson, 1996). The blank from the presence of redox species apart from oxygen in the reagents was determined as follows. 1 cm³ of the standard potassium iodate solution was added to a flask using a calibrated dispenser. Then 100 cm³ of deionized water, 1 cm³ of sulfuric acid solution, and 0.5 cm³ of pickling reagent solution II and I

were added into the flask in order. Just after titration of the first potassium iodate, a further 1 cm³ of standard potassium iodate was added and titrated. The blank was determined by difference between the first and second titrated volumes of the sodium thiosulfate.

The results are shown in Table 1, 2, 3, and 4. The blank was ranged from -0.012 to 0.003 cm³ (c.a. -0.7 ~ 0.2 $\mu\text{mol/kg}$). Most of them are negative, implying that there are deoxidizers in the reagents. We also found that the blank of DOT-2 is systematically larger than that of DOT-1 by about 0.003 cm³ (c.a. 0.2 $\mu\text{mol/kg}$). Because we could not explain the deoxidizers in the reagents and the systematic difference between DOT-1 and DOT-2, we assumed that the reagent blank due to redox species was negligible.

Table 3.3.1. Results of the standardization and the blank determinations during MR03-K04 leg 1.

Date (UTC)	Time (UTC)	KIO ₃		DOT-1 (cm ³)			DOT-2 (cm ³)			Samples (Stations)
		#	bottle	Na ₂ S ₂ O ₃	E.P.	blank	Na ₂ S ₂ O ₃	E.P.	blank	
08-03-03	18:44	1	030414-31	030411-7	3.969	-0.004	030411-8	3.969	-0.003	246,245,244
08-04-03	09:43		030414-32	030411-7	3.967	-0.008	030411-8	3.967	-0.002	243,242
08-04-03	15:57		030414-33	030411-7	3.964	-0.005	030411-8	3.968	-0.003	241
08-04-03	22:38		030414-34	030804-1	3.971	-0.006	030804-2	3.968	-0.006	240
08-05-03	05:09		030414-35	030804-1	3.968	-0.003	030804-2	3.966	-0.004	239
08-05-03	11:07		030414-36	030804-1	3.968	-0.003	030804-2	3.968	-0.003	238
08-05-03	16:53		030414-37	030804-1	3.966	-0.005	030804-2	3.968	-0.005	237
08-05-03	21:18		030414-38	030804-1	3.965	-0.005	030804-2	3.970	-0.004	X11
08-06-03	02:44		030414-39	030804-1	3.965	-0.002	030804-2	3.968	-0.005	235
08-06-03	09:50		030414-40	030804-3	3.970	-0.003	030804-4	3.971	-0.004	234,232
08-06-03	18:02		030414-41	030804-3	3.970	-0.005	030804-4	3.969	-0.005	231,230

08-06-03	23:48	1	030414-42	030804-3	3.967	-0.005	030804-4	3.969	-0.003	229,228
08-07-03	05:04		030414-43	030804-3	3.962	-0.006	030804-4	3.965	-0.004	227,226
08-07-03	14:14	2	030415-1	030804-5	3.968	-0.003	030807-1	3.958	-0.004	225,224,223
08-07-03	23:10		030415-2	030804-5	3.968	-0.008	030807-1	3.957	-0.005	222,221,220
08-08-03	07:11		030415-3	030804-5	3.965	-0.004	030807-1	3.957	-0.005	219,218
08-08-03	16:21		030415-4	030804-5	3.963	-0.007	030807-1	3.956	-0.005	217,216
08-09-03	01:30		030415-5	030804-5	3.963	-0.007	030807-1	3.951	-0.003	216
08-09-03	05:17		030415-6	030807-2	3.957	-0.006	030807-3	3.958	-0.004	215,214,213
08-10-03	13:48		030415-7	030807-2	3.954	-0.006	030807-3	3.956	-0.005	212,211
08-11-03	02:49		030415-8	030807-2	3.953	-0.005	030807-3	3.950	-0.003	210
08-11-03	06:31		030415-9	030807-2	3.953	-0.005	030807-3	3.951	-0.003	209,208
08-11-03	15:28		030415-10	030807-2	3.954	-0.007	030807-3	3.953	-0.003	207
08-11-03	21:44		030415-11	030807-4	3.957	-0.006	030807-5	3.959	-0.003	206,205
08-12-03	04:55		030415-12	030807-4	3.957	-0.008	030807-5	3.956	-0.002	204,203
08-12-03	12:36		030415-13	030807-4	3.954	-0.007	030807-5	3.955	-0.003	202,201
08-12-03	22:14	3	030415-16	030810-1	3.960	-0.008	030810-2	3.961	-0.003	200,199
08-13-03	04:12		030415-17	030810-1	3.959	-0.007	030810-2	3.958	-0.004	198,197
08-13-03	12:43		030415-18	030810-1	3.958	-0.007	030810-2	3.958	-0.002	196,195
08-13-03	23:12		030415-19	030810-1	3.958	-0.007	030810-2	3.959	-0.003	194,X14
08-14-03	12:08		030415-20	030810-3	3.961	-0.005	030810-4	3.961	-0.002	192,191
08-15-03	00:50		030415-21	030810-3	3.960	-0.007	030810-4	3.959	-0.002	190,186
08-15-03	10:32		030415-22	030810-3	3.960	-0.006	030810-4	3.959	-0.001	185,184
08-15-03	19:00		030415-23	030810-3	3.961	-0.006	030810-4	3.959	-0.002	183,182
08-16-03	05:06		030415-24	030810-5	3.963	-0.002	030815-1	3.960	-0.002	181,180

08-16-03	11:14	3	030415-25	030810-5	3.960	-0.006	030815-1	3.957	-0.002	179,178
08-17-03	23:02		030415-26	030810-5	3.960	-0.007	030815-1	3.953	0.001	177
08-18-03	04:19		030415-27	030810-5	3.960	-0.004	030815-1	3.951	-0.003	176
08-18-03	12:31	4	030415-31	030815-2	3.959	-0.007	030815-3	3.959	-0.003	175
08-18-03	17:45		030415-32	030815-2	3.960	-0.005	030815-3	3.955	-0.001	174
08-19-03	03:37		030415-33	030815-2	3.958	-0.006	030815-3	3.958	-0.001	173,172
08-19-03	18:00		030415-34	030815-2	3.958	-0.005	030815-3	3.958	-0.001	171
08-20-03	11:12		030415-36	030815-4	3.958	-0.005	030815-5	3.959	-0.002	170,169,168,167
08-20-03	21:21		030415-37	030815-4	3.960	-0.006	030815-5	3.960	0.001	166-1,2
08-21-03	03:54		030815-38	030815-4	3.960	-0.004	030815-5	3.959	0.001	165
08-21-03	12:46		030415-39	030819-1	3.960	-0.006	030819-2	3.961	0.000	164,163,162
08-22-03	03:43		030415-41	030819-1	3.957	-0.008	030819-2	3.958	-0.001	161,160
08-22-03	13:35		030415-42	030819-1	3.958	-0.008	030819-2	3.960	-0.001	159
08-22-03	19:24	030415-43	030819-1	3.959	-0.008	030819-2	3.958	-0.001	158	
08-23-03	05:01	5	030417-1	030819-3	3.960	-0.006	030819-4	3.961	0.000	X15,156
08-23-03	12:01		030417-2	030819-3	3.961	-0.005	030819-4	3.961	0.000	155,154
08-24-03	23:08		030417-3	030819-3	3.960	-0.006	030819-4	3.961	0.001	153,152
08-24-03	09:21		030417-4	030819-3	3.959	-0.006	030819-4	3.960	0.001	151
08-24-03	17:22		030417-5	030819-5	3.959	-0.008	030823-1	3.960	0.002	150,149
08-26-03	05:30		030417-6	030819-5	3.959	-0.007	030823-1	3.959	-0.002	148
08-26-03	16:05		030417-7	030819-5	3.957	-0.006	030823-1	3.959	0.000	147
08-26-03	22:48		030417-8	030819-5	3.958	-0.006	030823-1	3.960	0.000	146
08-27-03	05:13		030417-9	030819-5	3.957	-0.005	030823-1	3.956	0.002	145
08-27-03	12:49		030417-10	030823-2	3.959	-0.007	030823-3	3.957	-0.005	144,143

08-27-03	23:51	5	030417-11	030823-2	3.959	-0.007	030823-3	3.960	-0.004	142
08-28-03	04:50		030417-12	030823-2	3.959	-0.006	030823-3	3.958	-0.006	140
08-28-03	10:06		030417-13	030823-2	3.958	-0.004	030823-3	3.957	-0.004	139,138
08-28-03	02:25	6	030417-16	030823-4	3.961	-0.005	030823-5	3.962	-0.002	137,136
08-29-03	11:54		030417-17	030823-4	3.959	-0.005	030823-5	3.960	-0.003	135
08-29-03	19:00		030417-18	030823-4	3.961	-0.008	030823-5	3.963	0.001	134,133
08-30-03	06:30		030417-19	030823-4	3.959	-0.006	030823-5	3.960	-0.001	132,131
08-30-03	21:51		030417-20	030828-1	3.960	-0.005	030828-2	3.962	-0.003	130,129
08-31-03	07:44		030417-21	030828-1	3.960	-0.006	030828-2	3.963	-0.001	X16
08-31-03	15:51		030417-22	030828-1	3.961	-0.005	030828-2	3.962	-0.001	127
08-31-03	22:59		030417-23	030828-1	3.961	-0.005	030828-2	3.963	-0.001	126
09-01-03	04:50		030417-24	030828-1	3.962	-0.005	030828-2	3.963	-0.001	125
09-01-03	11:54		030417-25	030828-3	3.958	-0.007	030828-4	3.961	-0.002	124,123
09-02-03	00:17		030417-26	030828-3	3.959	-0.007	030828-4	3.962	0.000	122
09-02-03	06:12		030417-27	030828-3	3.958	-0.007	030828-4	3.958	-0.002	121

#: Batch number of the KIO₃ standard series.

Table 3.3.2. Results of the standardization and the blank determinations during MR03-K04 leg 2.

Date (UTC)	Time (UTC)	KIO ₃		DOT-1 (cm ³)			DOT-2 (cm ³)			Samples (Stations)
		#	bottle	Na ₂ S ₂ O ₃	E.P.	blank	Na ₂ S ₂ O ₃	E.P.	blank	
09-12-03	05:11	7	030417-31	030828-4	3.960	-0.006	030828-5	3.962	-0.001	127,125
09-13-03	12:38		030417-32	030910-1	3.961	-0.006	030910-2	3.964	0.000	120,119
09-14-03	11:22		030417-33	030910-1	3.959	-0.006	030910-2	3.963	0.000	118,117,116
09-15-03	07:24		030417-45	030910-3	3.961	-0.004	030910-4	3.963	0.001	115,114,113
09-15-03	20:23		030417-34	030910-3	3.961	-0.005	030910-4	3.963	0.001	112,111,110
09-16-03	16:05		030417-35	030910-5	3.962	-0.005	030910-6	3.961	0.002	109,108,X17
09-17-03	10:15		030417-36	030910-5	3.959	-0.004	030910-5	3.962	0.002	106,105,104
09-18-03	08:31		030417-37	030916-1	3.961	-0.004	030916-2	3.965	0.001	103,102,101
09-18-03	23:02		030417-38	030916-1	3.961	-0.005	030916-2	3.963	0.000	100,099,098
09-19-03	17:34		030417-39	030916-3	3.962	-0.005	030916-4	3.965	-0.002	097,096,095,094
09-21-03	03:48		030418-1	030916-6	3.966	-0.005	030916-7	3.970	0.002	093,092,091
09-21-03	21:40		030418-2	030916-6	3.966	-0.005	030916-7	3.968	-0.001	090,089,088,087
09-22-03	18:21		030418-3	030916-6	3.965	-0.004	030916-7	3.965	-0.001	086,085,084
09-23-03	11:27		030418-4	030921-1	3.966	-0.004	030921-2	3.968	-0.001	083,082,081
09-24-03	05:36	030418-5	030921-1	3.964	-0.005	030921-2	3.969	0.001	080,079,078,077	
09-25-03	07:20	030418-6	030921-3	3.965	-0.004	030921-4	3.968	0.002	076,075,072,071	
09-25-03	19:31	030418-7	030921-3	3.962	-0.003	030921-4	3.963	0.002	070,069,068,067	
09-26-03	18:45	030418-9	030921-6	3.964	-0.005	030921-7	3.970	-0.001	066,065,064	
09-27-03	13:12	030418-10	030921-6	3.968	-0.004	030921-7	3.971	0.001	063,062,061,060	
09-28-03	12:29	030418-11	030925-1	3.967	-0.004	030925-2	3.969	0.000	059,X18,056	
09-29-03	10:52	030418-12	030925-1	3.964	-0.005	030925-2	3.969	-0.001	055	

09-30-03	16:58		030418-16	030925-1	3.961	-	030925-2	3.967	-	054,053
10-01-03	05:09		030418-17	030925-3	3.964	-0.004	030925-4	3.970	0.000	052,051,050
10-01-03	18:34		030418-18	030925-3	3.967	-0.003	030925-4	3.967	0.000	049,048,047
10-02-03	11:46		030418-19	030925-6	3.963	-0.006	030925-7	3.968	0.000	046,045,044
10-03-03	03:43		030418-20	030925-6	3.964	-0.005	030925-7	3.970	0.003	043,042,041
10-03-03	19:06	9	030418-21	030930-1	3.963	-0.005	030930-2	3.968	0.002	040,039,038
10-04-03	10:37		030418-22	030930-1	3.963	-0.003	030930-2	3.965	-0.001	037,036,X19
10-05-03	06:03		030418-23	030930-3	3.964	-0.003	030930-4	3.970	-0.001	034,033,032
10-05-03	18:54		030418-24	030930-3	3.961	-0.003	030930-4	3.964	-0.002	031,030,029
10-06-03	12:07		030418-25	030930-6	3.964	-0.005	030930-7	3.966	-0.001	028,027,026
10-07-03	05:19		030418-26	030930-6	3.965	-0.005	030930-7	3.967	0.003	025,024
10-08-03	13:45		030418-32	031005-1	3.966	-0.005	031005-2	3.971	0.001	023,022,021
10-09-03	08:02		030418-33	031005-1	3.968	-0.004	031005-2	3.969	0.000	020,019,018
10-10-03	01:15	10	030418-34	031005-3	3.965	-0.006	031005-4	3.969	-0.001	017,016,015
10-10-03	15:13		030418-35	031005-3	3.966	-0.006	031005-4	3.970	0.000	014,013,012
10-11-03	09:23		030418-36	031005-6	3.966	-0.005	031005-7	3.969	-0.001	011,010,009
10-11-03	23:31		030418-37	031005-6	3.966	-0.003	031005-7	3.970	0.002	008,007,006,005,004

#: Batch number of the KIO₃ standard series.

Table 3.3.3. Results of the standardization and the blank determinations during MR03-K04 leg 4.

Date (UTC)	Time (UTC)	KIO ₃		DOT-1 (cm ³)			DOT-2 (cm ³)			Samples (Stations)
		#	bottle	Na ₂ S ₂ O ₃	E.P.	blank	Na ₂ S ₂ O ₃	E.P.	blank	
11-07-03	06:09		030418-47	031010-2	3.961	-0.005	031010-3	3.956	-0.007	622,623,624,625
11-07-03	23:26		030418-48	031010-2	3.960	-0.005	031010-3	3.957	-0.003	626,627,628
11-08-03	16:33		030418-49	031010-4	3.964	-0.005	031010-5	3.963	-0.004	629,630,631
11-09-03	00:46		030418-50	031010-4	3.965	-0.006	031010-5	3.964	-0.003	632,001,002
11-09-03	14:35		030418-51	031108-1	3.965	-0.005	031108-2	3.964	-0.004	003,004,005
11-10-03	08:15	11	030418-52	031108-1	3.963	-0.004	031108-2	3.963	-0.004	006,007,008
11-10-03	23:27		030418-53	031108-3	3.964	-0.006	031108-4	3.962	-0.005	009,010,011
11-11-03	14:49		030418-54	031108-3	3.962	-0.004	031108-4	3.960	-0.004	X17,013,014
11-12-03	05:04		030418-55	031108-5	3.963	-0.011	031111-1	3.959	-0.004	015,016,X.23, 018,019
11-12-03	21:01		030418-56	031108-5	3.964	-0.006	031111-1	3.959	-0.005	020,021,022,023,024
11-13-03	15:35		030418-57	031111-2	3.964	-0.005	031111-3	3.961	-0.010	025,026,027
11-14-03	04:13		030418-58	031111-2	3.963	-0.004	031111-3	3.961	-0.004	028,029,030
11-14-03	21:52		030418-61	031111-4	3.962	-0.006	031111-5	3.959	-0.004	031,032,033
11-15-03	15:48		030418-63	031111-4	3.959	-0.006	031111-5	3.958	-0.004	some samples of 031
11-16-03	07:14		030418-64	031111-4	3.958	-0.008	031111-5	3.954	-0.005	034,035,036
11-16-03	01:21		030418-65	031115-1	3.957	-0.008	031115-2	3.957	-0.004	037,038,039
11-17-03	18:47		030418-66	031115-1	3.956	-0.006	031115-2	3.957	-0.004	X16,041,042
11-18-03	18:16	12	030418-67	031115-3	3.960	-0.007	031115-4	3.959	-0.003	043,044,045
11-19-03	10:36		030418-68	031115-3	3.959	-0.006	031115-4	3.958	-0.003	046,X15,048
11-20-03	08:01		030418-69	031115-5	3.960	-0.006	031119-1	3.956	-0.004	049,050,051
11-20-03	22:47		030418-70	031115-5	3.950	-0.007	031119-1	3.948	-0.004	052,053,054
11-21-03	14:43		030418-71	031119-2	3.957	-0.006	031119-3	3.954	-0.004	055,056,057,058
11-22-03	10:19		030418-72	031119-2	3.953	-0.009	031119-3	3.952	-0.007	059,060,061
11-23-03	23:49		030418-75	031119-4	3.956	-0.010	031119-5	3.955	-0.007	X14,063,064,065,066 067

11-25-03	10:00		030418-76	031125-1	3.963	-0.009	031125-2	3.961	-0.007	068,069,070
11-26-03	07:54		030418-77	031125-1	3.959	-0.009	031125-2	3.957	-0.006	071,072,073
11-27-03	04:47		030418-78	031125-3	3.958	-0.008	031125-4	3.959	-0.006	074,075,076
11-27-03	17:17		030418-79	031125-3	3.958	-0.011	031125-4	3.959	-0.006	077,078,079
11-28-03	10:24	13	030418-80	031125-5	3.957	-0.010	031128-1	3.959	-0.007	080,081,082
11-29-03	01:19		030418-81	031125-5	3.955	-0.010	031128-1	3.959	-0.006	083,084,085
11-30-03	01:21		030418-82	031128-2	3.961	-0.011	031128-3	3.960	-0.004	086,087,X13
11-30-03	18:09		030418-83	031128-2	3.958	-0.009	031128-3	3.960	-0.006	089,090,091
12-01-03	19:56		030418-84	031128-4	3.960	-0.011	031128-5	3.963	-0.004	092,093,094
12-02-03	06:02		030418-85	031128-4	3.962	-0.008	031128-5	3.962	-0.005	095,096,097,098,099 100

#: Batch number of the KIO₃ standard series.

Table 3.3.4. Results of the standardization and the blank determinations during MR03-K04 leg 5.

Date (UTC)	Time (UTC)	KIO ₃		DOT-1			DOT-2			Stations
		#	bottle	Na ₂ S ₂ O ₃	E.P.	Blank	Na ₂ S ₂ O ₃	E.P.	Blank	
12-13-03	02:32	14	030418-91	031209-1	3.961	-0.008	031209-2	3.962	-0.006	610,609,608,607,606 605
12-14-03	01:07		030418-92	031209-1	3.957	-0.009	031209-2	3.959	-0.007	604,603,602
12-14-03	12:06		030418-93	031209-6	3.959	-0.012	031209-7	3.960	-0.008	601,600,599
12-15-03	01:14		030418-94	031209-6	3.960	-0.011	031209-7	3.961	-0.008	598,597,596
12-16-03	00:43		030418-96	031209-6	3.958	-0.008	031209-7	3.959	-0.008	595,594
12-16-03	01:59		030418-96	031209-4	3.955	-0.011	031209-5	3.959	-0.010	593,592,591
12-16-03	15:28		030418-97	031209-4	3.957	-0.012	031209-5	3.960	-0.007	590,589,588
12-17-03	05:40		030418-98	031209-4	3.959	-0.011	031209-5	3.960	-0.008	587,586,585
12-19-03	05:30		030418-100	031215-1	3.957	-0.011	031215-2	3.959	-0.008	562,561,560,559
12-20-03	22:34		030418-102	031215-1	3.953	-0.011	031215-2	3.955	-0.009	558,557,556
12-21-03	18:52		030418-106	031215-3	3.955	-0.012	031215-4	3.956	-0.008	555,554,553
12-22-03	06:22		030418-107	031215-3	3.958	-0.012	031215-4	3.958	-0.009	552,551,550
12-23-03	02:12		030418-108	031215-5	3.956	-0.012	031221-1	3.955	-0.008	549,X07,547
12-23-03	17:53		030418-109	031215-5	3.958	-0.011	031221-1	3.955	-0.009	546,545,544
12-24-03	10:01	15	030418-110	031221-2	3.955	-0.011	031221-3	3.957	-0.007	543,542,541,540
12-24-03	23:05		030418-111	031221-2	3.956	-0.011	031221-3	3.957	-0.007	539,538,537,536
12-25-03	21:06		030418-112	031221-4	3.956	-0.011	031221-5	3.956	-0.009	535,534,533
12-28-03	01:07		030418-114	031221-4	3.955	-0.010	031221-5	3.957	-0.008	532,531,530
12-28-03	22:01		030418-115	031224-1	3.953	-0.009	031224-2	3.954	-0.010	529,528,527
12-29-03	09:07		030418-116	031224-1	3.955	-0.011	031224-2	3.955	-0.008	526,525,524,523

12-30-03	01:45	15	030418-117	031224-3	3.956	-0.009	031224-4	3.957	-0.008	522,521,520
12-30-03	16:51		030418-118	031224-3	3.954	-0.009	031224-4	3.956	-0.008	519,518,517
12-31-03	05:55	16	030418-121	031224-5	3.957	-0.012	031229-1	3.961	-0.008	516,515,514
01-01-04	15:35		030418-123	031224-5	3.954	-0.009	031229-1	3.958	-0.007	513,512,511
01-02-04	09:30		030418-124	031229-2	3.961	-0.009	031229-3	3.961	-0.007	510,509,508
01-03-04	23:45		030418-125	031229-2	3.960	-0.009	031229-3	3.959	-0.008	507,506,505
01-03-04	21:41		030418-126	031229-4	3.958	-0.010	031229-5	3.958	-0.008	504,503,502
01-04-04	17:47		030418-127	031229-4	3.959	-0.009	031229-5	3.958	-0.009	501,500,X08
01-05-04	10:36		030418-128	031229-6	3.956	-0.008	040102-1	3.958	-0.007	498,497,496
01-06-04	04:57		030418-129	031229-6	3.958	-0.009	040102-1	3.958	-0.008	495,494,493
01-07-04	01:09		030418-130	040102-2	3.960	-0.010	040102-3	3.959	-0.008	492,491,490,489
01-08-04	19:31		030418-136	040102-2	3.961	-0.009	040102-3	3.961	-0.007	488,487,486,485
01-09-04	16:37	030418-137	040102-4	3.961	-0.009	040102-5	3.960	-0.008	484,483,482	
01-10-04	04:46	030418-138	040102-4	3.959	-0.010	040102-5	3.959	-0.008	481,480,479	
01-11-04	00:24	030418-139	040108-1	3.960	-0.009	040108-2	3.960	-0.007	478,477,476	
01-11-04	17:58	17	030418-140	040108-1	3.959	-0.009	040108-2	3.959	-0.008	475,474,473
01-13-04	08:41		030418-142	040108-3	3.958	-0.009	040108-4	3.960	-0.007	X09,471,470,469,468
01-14-04	04:55		030418-144	040108-5	3.956	-0.010	040112-1	3.958	-0.007	467,466,465
01-16-04	04:38		030418-146	040108-5	3.958	-0.009	040112-1	3.960	-0.008	464,463,462
01-17-04	04:00		030418-147	040112-2	3.958	-0.010	040112-3	3.959	-0.008	461,460,459
01-18-04	02:31		030418-148	040112-2	3.959	-0.010	040112-3	3.959	-0.008	458,457,456
01-19-04	01:40		030418-151	040112-4	3.959	-0.008	040112-5	3.959	-0.008	455,454,X10
01-19-04	20:27		030418-152	040112-4	3.959	-0.008	040112-5	3.960	-0.008	452,451,450
01-20-04	21:05	030418-155	040112-4	3.962	-0.009	040112-5	3.961	-0.007	449,448,447(DOT-02)	

#: Batch number of the KIO₃ standard series.

(4) Reproducibility of sample measurement

Replicate samples were taken at every CTD cast. These were 5 - 10 % of seawater samples of each cast. Results of the replicate samples were shown in Table 3.3.5. The standard deviation of the replicate measurement was about 0.1 $\mu\text{mol/kg}$ during the whole legs (leg 1, 2, 4, and 5) and there was no significant difference between DOT-1 and DOT-2 measurements. The standard deviation was calculated by a procedure (SOP23) in DOE (1994).

Table 3.3.5. Results of the replicate sample measurements.

	Leg 1	Leg 2	Leg 4	Leg 5
Number of replicate sample pairs	388	380	368	489
Standard deviation ($\mu\text{mol/kg}$)	0.09	0.13	0.09	0.08

(5) CSK standard measurements

During the whole legs (leg 1, 2, 4, and 5), we carried out measurement of the CSK standard solution of potassium iodate every the KIO₃ standard series (# in Table 1) in order to trace stability of our oxygen measurement on board. Table 3.3.6 shows the result of the CSK standard measurements. Averaged values all through the legs of DOT-1 and DOT-2 are $0.009991 \pm 0.000006 \text{ N}$ and $0.009991 \pm 0.000005 \text{ N}$ respectively, suggesting that there was no systematic difference between DOT-1 and DOT-2 measurements. Furthermore, these results indicate stability of oxygen measurement during the whole legs. The averaged value of the CSK standard solution is so close to the certified value (0.0100 N) that we did not correct sample measurements with the CSK standard measurements.

Table 3.3.6. Results of the CSK standard measurements.

Leg	Date (UTC)	Time (UTC)	KIO ₃ #	DOT-1		DOT-2	
				Conc. (N)	error (N)	Conc. (N)	error (N)
1	08-03-03	17:49	1	0.009998	0.000008	0.009989	0.000003
1	08-08-03	06:11	2	0.009990	0.000005	0.009990	0.000009
1	08-13-03	11:28	3	0.009988	0.000003	0.009987	0.000007
1	08-19-03	02:58	4	0.009983	0.000003	0.009994	0.000005
1	08-23-03	22:26	5	0.009988	0.000002	0.009993	0.000004
1	09-02-03	12:42	6	0.009989	0.000002	0.009989	0.000004
2	09-12-03	14:35	7	0.009994	0.000003	0.009988	0.000004
2	09-21-03	22:42	8	0.009983	0.000003	0.009984	0.000008
2	10-01-03	18:01	9	0.009985	0.000007	0.009983	0.000007
2	10-09-03	07:23	10	0.009985	0.000004	0.009990	0.000003
4	11-07-03	08:21	11	0.009991	0.000004	0.009985	0.000008
4	11-17-03	21:15	12	0.009993	0.000012	0.009997	0.000004
4	11-27-03	18:37	13	0.009985	0.000003	0.009988	0.000006
5	12-13-03	06:29	14	0.009996	0.000002	0.009994	0.000002
5	12-23-03	17:00	15	0.010002	0.000001	0.009997	0.000001
5	01-03-04	02:24	16	0.009999	0.000002	0.009997	0.000004
5	01-10-04	05:51	17	0.009997	0.000003	0.009994	0.000002
5	01-19-04	22:35	18	0.009999	0.000001	0.009996	0.000002
average				0.009991	0.000006	0.009991	0.000005

(6) Quality control flag assignment

Quality flag values were assigned to oxygen measurements using the code defined in Table 0.2 of WHP Office Report WHPO 91-1 Rev.2 section 4.5.2 (Joyce *et al.*, 1994). Measurement flags of 2, 3, 4, and 5 have been assigned (Table 3.3.7). For the choice between 2 (good), 3 (questionable) or 4 (bad), we basically followed a flagging procedure as listed below:

- a. On a station-by-station basis, a datum was plotted against depth. Any points not lying on a generally smooth trend were noted.
- b. If the bottle flag was marked with “problem”, a datum was noted and flagged 3.
- c. Dissolved oxygen was then plotted against nitrate concentration and CTD oxygen. If a datum deviated from both the depth and plots, it was flagged 3.
- d. Vertical sections against depth and potential density were drawn. If a datum was anomalous on the section plots, datum flag was degraded from 2 to 3, or from 3 to 4.
- e. We did not use flag of 6 for the replicate samples. If both of replicate sample data were flagged 2, averaged value was shown with flag of 2. If either of them was flagged 3 or 4, a datum with a younger flag was shown.

Table 3.3.7. Summary of assigned quality control flags.

Flag	Definition	Leg 1	Leg 2	Leg 4	Leg 5
2	Good	3373	3101	2850	3969
3	Questionable	9	9	15	1
4	Bad	18	29	17	23
5	Not report (missing)	8	8	3	6
Total		3408	3147	2885	3999

References

Dickson, A. (1996): Dissolved Oxygen, in WHP Operations and Methods, Woods Hole, pp 1-13.

DOE (1994): Handbook of methods for the analysis of the various parameters of the carbon dioxide system in sea water; version 2. A.G. Dickson and C. Goyet (eds), ORNL/CDIAC-74.

Joyce, T., and C. Corry, eds., C. Corry, A. Dessier, A. Dickson, T. Joyce, M. Kenny, R. Key, D. Legler, R. Millard, R. Onken, P. Saunders, M. Stalcup, contrib. (1994): Requirements for WOCE Hydrographic Programme Data Reporting, WHPO Pub. 90-1 Rev. 2, 145 pp.

3.4 Nutrients

3 February 2005

(1) Personnel

Michio Aoyama (Meteorological Research Institute / Japan Meteorological Agency,

Principal Investigator)

Junko Hamanaka (Marine Works Japan Ltd.)

Asako Kubo (Marine Works Japan Ltd.)

Yuki Otsubo (Marine Works Japan Ltd.)

Kenichiro Sato (Marine Works Japan Ltd.)

Ai Yasuda (Marine Works Japan Ltd.)

Shinichiro Yokogawa (Marine Works Japan Ltd.)

(2) Objectives

The objectives of nutrients analyses during the R/V Mirai around the world cruises along ca. 30 °S in the Southern Hemisphere are as follows;

Describe the present status of nutrients in 2003-2004 in good traceability throughout the cruises. The target nutrients are nitrate, nitrite, phosphate and silicate (Although silicic acid is correct, we use silicate because a term of silicate is widely used in oceanographic community).

Study the temporal and spatial variation of nutrients based on the previous high quality experiments data of WOCE, GOSECS, IGY and so on.

Study of temporal and spatial variation of nitrate: phosphate ratio, so called Redfield ratio.

Obtain more accurate estimation of total amount of nitrate, phosphate and silicate in the interested area.

Provide more accurate nutrients data for physical oceanographers to use as tracers of water mass movement.

(3) Equipment and techniques

a. Analytical detail using TRAACS 800 systems (BRAN+LUEBBE)

The phosphate analysis is a modification of the procedure of Murphy and Riley (1962).

Molybdc acid is added to the seawater sample to form phosphomolybdc acid which is in turn reduced to phosphomolybdous acid using L-ascorbic acid as the reductant.

Nitrate + nitrite and nitrite are analyzed according to the modification method of Grasshoff (1970).

The sample nitrate is reduced to nitrite in a cadmium tube inside of which is coated with metallic copper. The sample stream with its equivalent nitrite is treated with an acidic, sulfanilamide reagent and the nitrite forms nitrous acid which reacts with the sulfanilamide to produce a diazonium ion. N1-Naphthylethylene-diamine added to the sample stream then couples with the diazonium ion to produce a red, azo dye. With reduction of the nitrate to nitrite, both nitrate and nitrite react and are measured; without reduction, only nitrite reacts. Thus, for the nitrite analysis, no reduction is performed and the alkaline buffer is not necessary. Nitrate is computed by difference.

The silicate method is analogous to that described for phosphate. The method used is essentially that of Grasshoff et al. (1983), wherein silicomolybdc acid is first formed from the silicic acid in the sample and added molybdc acid; then the silicomolybdc acid is reduced to silicomolybdous acid, or "molybdenum blue," using ascorbic acid as the reductant.

The flow diagrams and reagents for each parameter are shown in Figures 3.4.1-3.4.4.

Nitrate Reagents

Imidazole (buffer), 0.06M (0.4 % w/v)

Dissolve 4 g imidazole, $C_3H_4N_2$, in ca. 900 ml DIW; add 2ml concentrated HCl; make up to 1000 ml with DIW.

After mixing, 1 ml Triton(R)X-100 (50 % solution in ethanol) is added.

Sulfanilamide, 0.06M (1 % w/v) in 1.2M HCl

Dissolve 10 g sulfanilamide, $4-NH_2C_6H_4SO_3H$, in 1000ml of 1.2M (10 %) HCl. After mixing, 1 ml Triton(R)X-100

(50 % solution in ethanol) is added.

N-1-Naphthylethylene-diamine dihydrochloride, 0.004 M (0.1 % w/v)

Dissolve 1 g NEDA, $C_{10}H_7NHCH_2CH_2NH_2 \cdot 2HCl$, in 1000 ml of DIW; containing 10 ml concentrated HCl. Stored in a dark bottle.

Nitrite Reagents

Sulfanilamide, 0.06M (1 % w/v) in 1.2M HCl

Dissolve 10 g sulfanilamide, $4-NH_2C_6H_4SO_3H$, in 1000 ml of 1.2M (10 %) HCl. After mixing, 1 ml Triton(R)X-100

(50 % solution in ethanol) is added.

N-1-Naphthylethylene-diamine dihydrochloride , 0.004 M (0.1 % w/v)

Dissolve 1 g NEDA, $C_{10}H_7NHCH_2CH_2NH_2 \cdot 2HCl$, in 1000 ml of DIW; containing 10 ml concentrated HCl. Stored in a dark bottle.

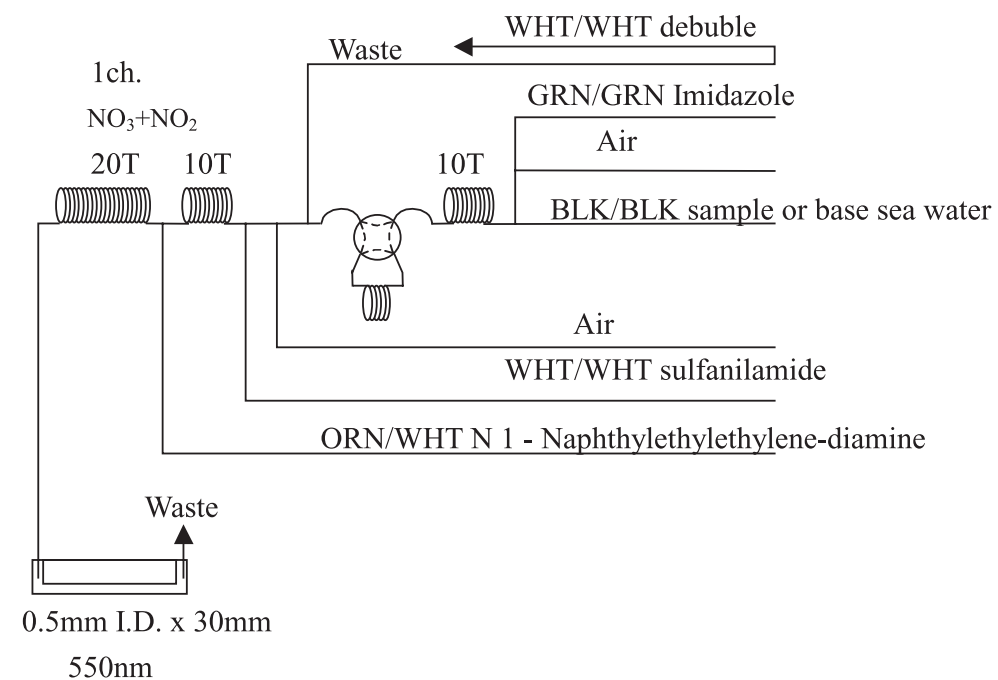

Figure 3.4.1. 1ch. (NO_3+NO_2) flow diagram.

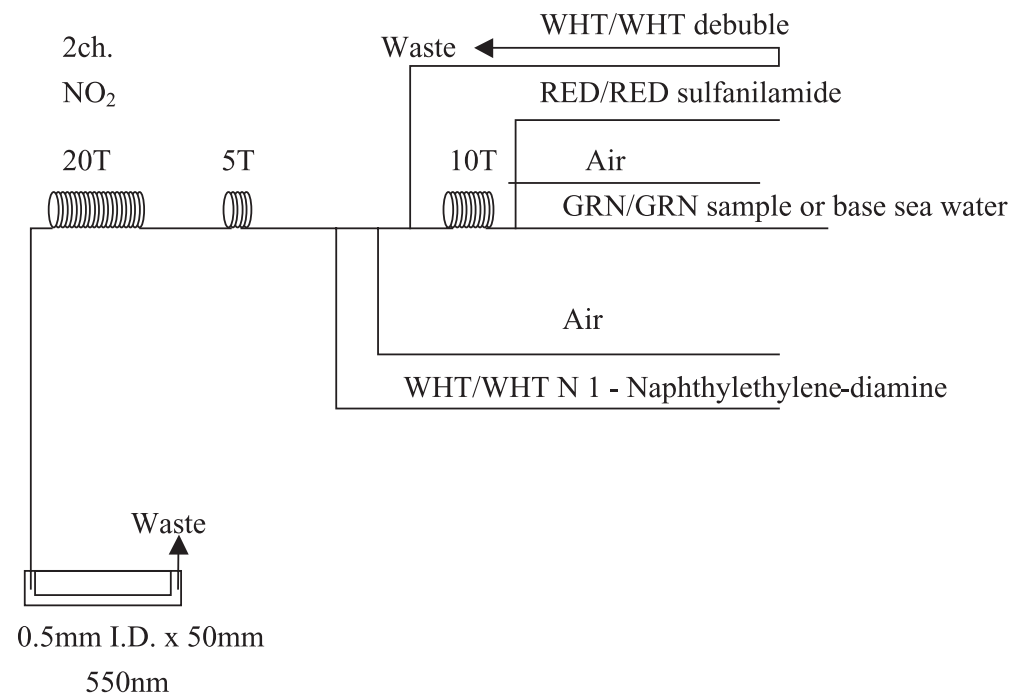

Figure 3.4.2. 2ch. (NO₂) flow diagram.

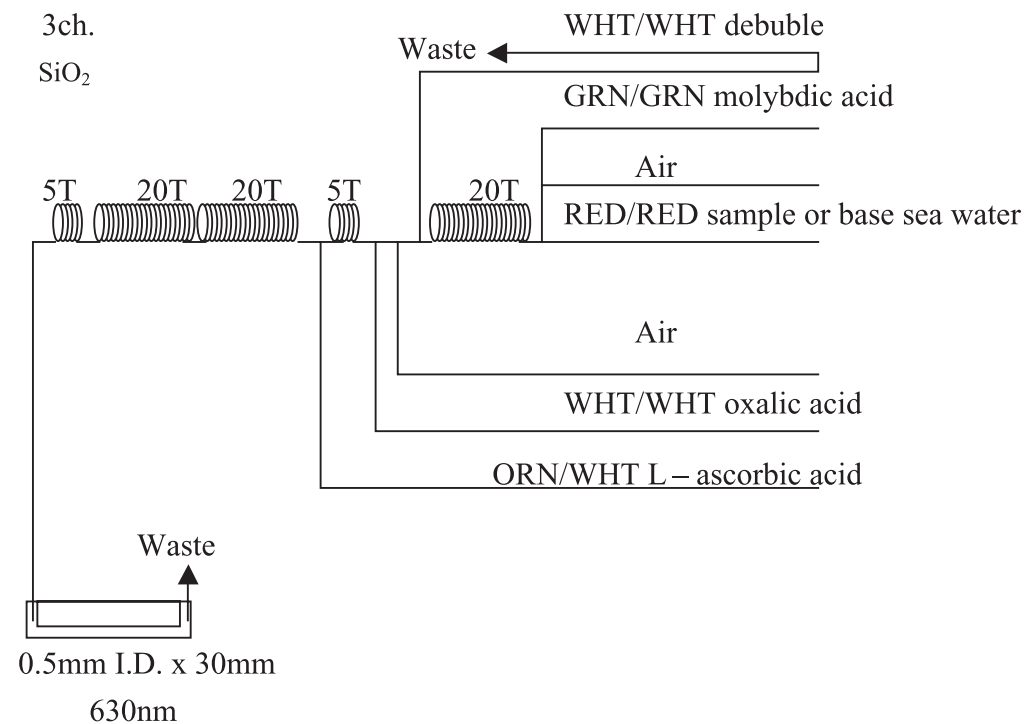

Figure 3.4.3. 3ch. (SiO₂) flow diagram.

Silicic Acid Reagents

Molybdic acid, 0.06M (2 % w/v)

Dissolve 15 g Disodium Molybdate (VI) Dihydrate, Na₂MoO₄ · 2H₂O, in 1000 ml DIW containing 6 ml H₂SO₄.

After mixing, 20 ml sodium dodecyl sulphate (15 % solution in water) is added.

Oxalic acid, 0.6M (5 % w/v)

Dissolve 50 g Oxalic Acid Anhydrous, HOOC: COOH, in 1000 ml of DIW.

Ascorbic acid, 0.01M (3 % w/v)

Dissolve 2.5 g L (+)-Ascorbic Acid, C₆H₈O₆, in 100 ml of DIW. Stored in a dark bottle and freshly prepared before every measurement.

Phosphate Reagents

Stock molybdate solution, 0.03M (0.8 % w/v)

Dissolve 8 g Disodium Molybdate (VI) Dihydrate, Na₂MoO₄ · 2H₂O, and 0.17 g Antimony Potassium Tartrate, C₈H₄K₂O₁₂Sb₂ · 3H₂O, in 1000 ml of DIW containing 50 ml concentrated H₂SO₄.

Mixed Reagent

Dissolve 0.8 g L (+)-Ascorbic Acid, C₆H₈O₆, in 100 ml of stock molybdate solution. After mixing, 2 ml sodium dodecyl sulphate (15 % solution in water) is added. Stored in a dark bottle and freshly prepared before every measurement.

PO₄ dilution

Dissolve Sodium Hydrate, NaCl, 10 g in ca. 900 ml, add 50 ml Acetone and 4 ml concentrated H₂SO₄, make up to 1000 ml. After mixing, 5 ml sodium dodecyl sulphate (15 % solution in water) is added.

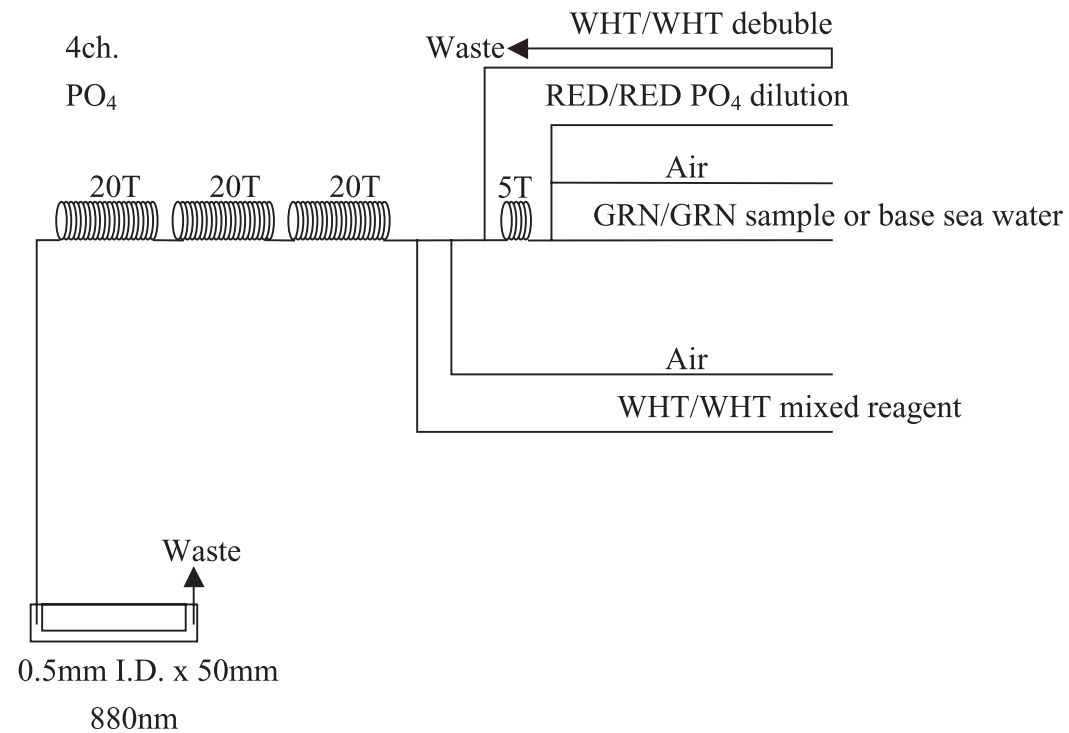

Figure 3.4.4. 4ch. (PO₄) flow diagram.

b. Sampling procedures

Sampling of nutrients followed that oxygen, trace gases and salinity. Samples were drawn into two of virgin 10 ml polyacrylates vials without sample drawing tubes. These were rinsed three times before filling and vials were capped immediately after the drawing. The vials are put into water bath at 23 °C in 10 minutes before use to stabilize the temperature of samples.

No transfer was made and the vials were set an auto sampler tray directly. Samples were analyzed as rapidly

as possible after collection, and then the samples were analyzed within 5 hours.

c. Data processing

Raw data from TRAACS800 were treated as follows;

Check baseline shift.

Check the shape of each peak and positions of peak values taken, and then change the positions of peak values taken if necessary.

Carriover correction and baseline drift correction were applied to peak heights of each samples followed by sensitivity correction.

Baseline correction and sensitivity correction were done basically using liner regression.

Load pressure and salinity from CTD data to calculate density of seawater.

Calibration curves to get nutrients concentration were assumed second order equations.

(4) Nutrients standards

a. In-house standards

(i) Volumetric Laboratory Ware

All volumetric glass- and plastic (PMP)-ware used were gravimetrically calibrated. Plastic volumetric flasks were gravimetrically calibrated at the temperature of use within 2-3 K.

Volumetric flasks

Volumetric flasks of Class quality (Class A) are used because their nominal tolerances are 0.05 % or less over the size ranges likely to be used in this work. Class A flasks are made of borosilicate glass, and the standard solutions were transferred to plastic bottles as quickly as possible after they are made up to volume and well mixed in order to prevent excessive dissolution of silicic acid from the glass. High quality plastic (polymethylpentene, PMP, or polypropylene) volumetric flasks were gravimetrically calibrated and used only

within 2-3 K of the calibration temperature.

The computation of volume contained by glass flasks at various temperatures other than the calibration temperatures were done by using the coefficient of linear expansion of borosilicate crown glass.

Because of their larger temperature coefficients of cubical expansion and lack of tables constructed for these materials, the plastic volumetric flasks were gravimetrically calibrated over the temperature range of intended use and used at the temperature of calibration within 2 K. The weights obtained in the calibration weightings were corrected for the density of water and air buoyancy.

Pipettes and pipettors

All pipettes have nominal calibration tolerances of 0.1 % or better. These were gravimetrically calibrated in order to verify and improve upon this nominal tolerance.

(ii) Reagents, General considerations

General Specifications

All reagents were of very high purity such as "Analytical Grade," "Analyzed Reagent Grade" and others. And assay of nitrite was determined according JISK8019 and assays of nitrite salts were 98.9 %. We use that value to adjust the weights taken.

For the silicate standards solution, we use commercial available silicon standard solution for atomic absorption spectrometry of 1000 mg L⁻¹. Since this solution is alkaline solution of 0.5 M KOH, an aliquot of 70 ml solution were diluted to 500 ml as B standard together with an aliquot of 35 ml of 1M HCl. Then the pH of B standard for silicate prepared to be 6.9.

Ultra pure water

Ultra pure water (MilliQ water) freshly drawn was used for preparation of reagents, higher concentration standards and for measurement of reagent and system blanks.

Low-Nutrient Seawater (LNSW)

Surface water having low nutrient concentration was taken and filtered using 0.45 μm pore size membrane filter. This water is stored in 20 liter cubitainer with paper box. The concentrations of nutrient of this water were measured carefully in May 2003.

(iii) Concentrations of nutrients for A, B and C standards

Concentrations of nutrients for A, B and C standards are set as shown in Table 3.4.1. The C standard is prepared according recipes as shown in Table 3.4.2. All volumetric laboratory tools were calibrated prior the cruise as stated in chapter (i). Then the actual concentration of nutrients in each fresh standard was calculated based on the ambient, solution temperature and determined factors of volumetric lab. wares.

Table 3.4.1. Nominal concentrations of nutrients for A, B and C standards.

	A	B	C-1	C-2	C-3	C-4	C-5
NO ₃ (μM)	45000	1350	0.0	13.5	27.0	40.5	54.0
NO ₂ (μM)	4000	40	0.0	0.4	0.8	1.2	1.6
SiO ₂ (μM)	36000	5040	0.0	50	100	150	200
PO ₄ (μM)	4500	90	0.0	0.9	1.8	2.7	3.6

Table 3.4.2. Working calibration standard recipes.

C-STD	B-1 STD	B-2 STD	MAT
C-1	0 ml	0 ml	40 ml
C-2	5 ml	5 ml	30 ml
C-3	10 ml	10 ml	20 ml
C-4	15 ml	15 ml	10 ml
C-5	20 ml	20 ml	0 ml

B-1 STD: Mixture of nitrate, silicate and phosphate

B-2 STD: Nitrite

(iv) Renewal of in-house standard solutions

In-house standard solutions as stated in (iii) were renewed as shown in Table 3.4.3.

Table 3.4.3. Timing of renewal of in-house standards.

NO ₃ , SiO ₂ , PO ₄	Renewal
A-1 Std. (NO ₃)	maximum 10 days
A-3 Std. (SiO ₂)	commercial prepared solution
A-4 Std. (PO ₄)	maximum 14 days
B-1 Std. (mixture of NO ₃ , SiO ₂ , PO ₄)	2 days

NO ₂	Renewal
A-2 Std. (NO ₂)	maximum 14 days
B-2 Std. (NO ₂)	maximum 14 days

C Std	Renewal
C-1 ~ C-5 Std (mixture of B1 and B2 Std.)	24 hours

Reduction estimation	Renewal
D-1 Std.	when A-1renewed
44 μM NO ₃	when C-std renewed
47 μM NO ₂	when C-std renewed

b. RMNS

To get the more accurate and high quality nutrients data to achieve the objectives stated above, huge numbers of the bottles of the reference material of nutrients in seawater (hereafter RMNS) are prepared (Aoyama et al., submitted). In the previous world wide expeditions, such as WOCE cruises, the higher reproducibility and precision of nutrients measurements were required (Joyce and Corry, 1994). Since no standards were available for the measurement of nutrients in seawater at that time, the requirements were described in term of reproducibility. The required reproducibility was 1 %, 1-2 %, 1-3 % for nitrate, phosphate and silicate, respectively. Although nutrient data from the WOCE one-time survey was of unprecedented quality and coverage due to much care in sampling and measurements, the differences of nutrients concentration at crossover points are still found among the expeditions (Aoyama and Joyce, 1996, Mordy et al., 2000, Gouretski and Jancke, 2001). For instance, the mean offset of nitrate concentration at deep waters was 0.5 μmol kg⁻¹ for 345 crossovers at world oceans, though the maximum was 1.7 μmol kg⁻¹ (Gouretski and Jancke, 2001). At the 31 crossover points in the Pacific WHP one-time lines, the WOCE standard of reproducibility for nitrate of 1 % was fulfilled at about half of the crossover points and the maximum difference was 7% at deeper layers below 1.6 °C in potential temperature (Aoyama and Joyce, 1996).

(i) RMNS preparation

RMNS preparation and homogeneity for previous lots

The study on reference material for nutrients in seawater (RMNS) on the seawater base has been carried out to establish traceability on nutrient analyses in seawater since 1994 in Japan. Autoclaving to produce RMNS has been studied (Aminot and Kerouel, 1991, 1995) and autoclaving was used to stabilize the samples for the 5th intercomparison exercise in 1992/1993 (Aminot and Kirkwood, 1995). Aminot and Kerouel (1995) concluded that nitrate and nitrite were extremely stable throughout their 27 months storage experiment with overall standard deviations lower than 0.3 % (range 5-50 $\mu\text{mol l}^{-1}$) and 0.8 % (range 0.5-5 $\mu\text{mol l}^{-1}$), respectively. For phosphate, slight increase by 0.02-0.07 $\mu\text{mol l}^{-1}$ per year was observed due to the leaching from the container glass. The main source of nutrient variation in seawater is believed to be microorganism activity, hence, production of RMNS depends on biological inactivation of samples. In this point of view, previous study showed that autoclaving to inactivate the biological activity is acceptable for RMNS preparation.

The seawater for RMNS production was sampled in the North Pacific Ocean at the depths of surface where the nutrients are almost depleted and 1500-2000 meters depth where the nutrients concentrations are the maximum. The seawater was gravity-filtered through a membrane filter with a pore size of 0.45 μm (Millipore HA). The latest procedure of autoclaving for RMNS preparation is that the seawater in a stainless steel container of 40 liters was autoclaved at 120 °C, 2 hours, 2 times during two days. The filling procedure of autoclaved seawater was basically same throughout our study. Following cooling at room temperature in two days, polypropylene bottle of 100 ml capacity were filled by the autoclaved seawater of 90 ml through a membrane filter with a pore size of 0.2 μm (Millipore HA) at a clean bench in a clean room. The polypropylene caps were immediately tightly screwed on and a label containing lot number and serial number of the bottle was attached on all of the bottles. Then the bottles were vacuum-sealed to avoid potential contamination from the environment.

180 RMNS packages and 500 bottles of lot AH for this cruise

RMNS lots T, AN, AK, AM and O are prepared to cover the nutrients concentrations in the interested sea

area. About 180 sets of 5 RMNS lots are prepared. These packages will be used daily when in-house standard solutions renewed daily. 500 bottles of RMNS lot AH are prepared to use every analysis at every hydrographic stations planned about 500 during the cruise. These RMNS assignment were completely done based on random number. The RMNS bottles were stored at a room, REGENT STORE, where the temperature was maintained around 22 °C.

(ii) The homogeneity of RMNS and consensus values of the lot AH

The homogeneity of lot AH and analytical precision are shown in Table 3.4.4. These are for the assessment of the magnitude of homogeneity of the RMNS bottles those are used during the cruise. As shown in Table 3.4.4, the homogeneity of RMNS lot AH for nitrate and silicate are the same magnitude of analytical precision derived from fresh raw seawater. The homogeneity for phosphate, however, exceeded the analytical precision at about factor two. The homogeneity for lot AH is same order of magnitude for previous RMNS of lot K.

Table 3.4.4. Homogeneity of lot AH derived from 30 samples measurements and analytical precision onboard R/V Mirai in May 2003.

	Phosphate CV%	Nitrate	Silicate
RMNS			
AH	0.83 %	0.39 %	0.13 %
(K)	(1.0 %)	(0.3 %)	(0.2 %)
Precision	0.39 %	0.36 %	0.13 %

Note: N = 30 x 2

(5) Quality control

a. Precision of nutrients analyses during the cruise

Precision of nutrients analyses during the cruise was evaluated based on the 13 measurements, which are measured every 10-15 samples, during a run at the concentration of C-5. We also evaluated the reproducibility based on the replicate analyses of five samples in each run. Summary of precisions are shown in Table 3.4.5. As shown in Table 3.4.5 and Figures 3.4.5-3.4.7, the precisions for each parameter are generally good considering the analytical precisions estimated from the simultaneous analyses of 60 samples in May 2003. Analytical precisions previously evaluated were 0.39 % for phosphate, 0.36 % for nitrate and 0.13 % for silicate, respectively. During leg 5, analytical precisions were 0.17 % for phosphate, 0.13 % for nitrate and 0.12 % for silicate in terms of median, respectively. Then we can conclude that the analytical precisions for phosphate, nitrate and silicate were maintained or better throughout leg 5 comparing the pre-cruise evaluations.

Table 3.4.5. Summary of precision based on the replicate analyses of 13 samples in each run through out cruise.

	Nitrate	Phosphate	Silicate
	CV%	CV%	CV%
Median	0.15	0.18	0.15
Mean	0.16	0.19	0.16
Maximum	1.37	1.10	0.4
Minimum	0.04	0.06	0.04
N	491	490	490

The time series of precision are shown in Figures 3.4.5-3.4.7.

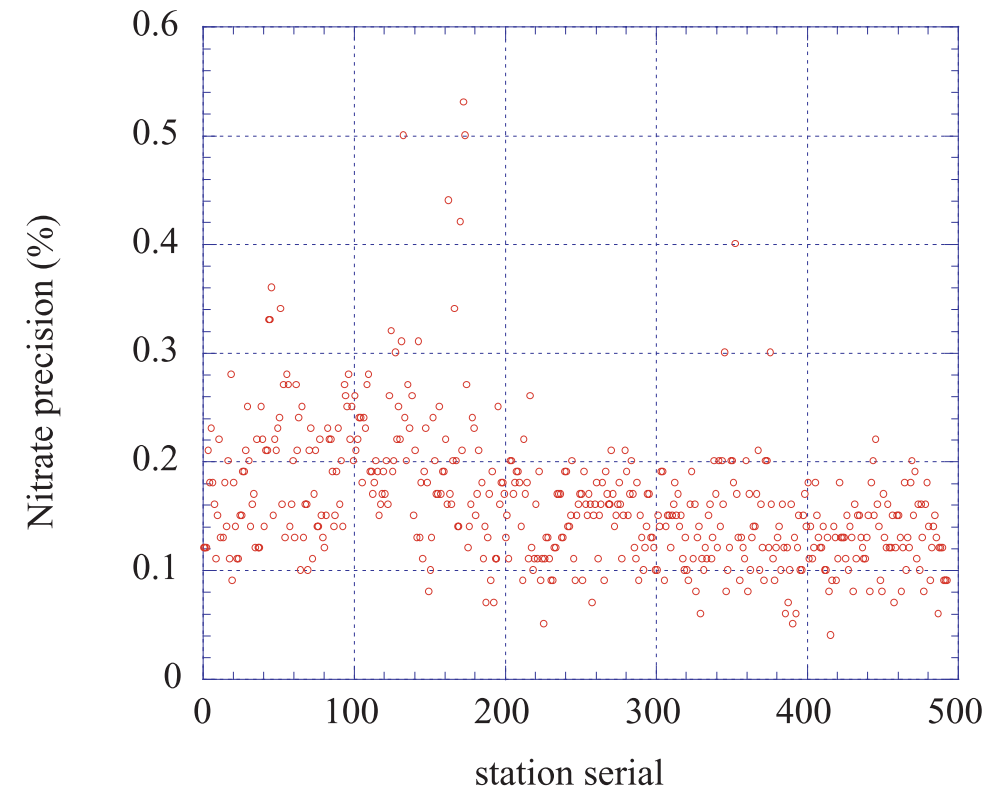

Figure 3.4.5. Time series of precision of nitrate.

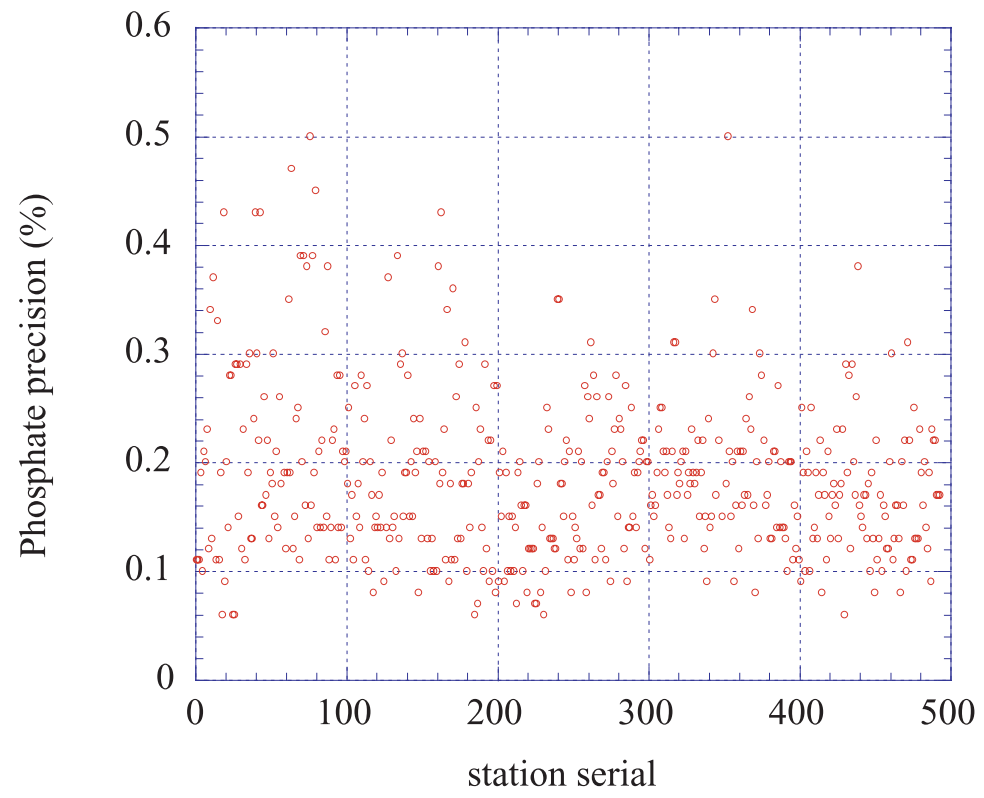

Figure 3.4.6. Time series of precision of phosphate.

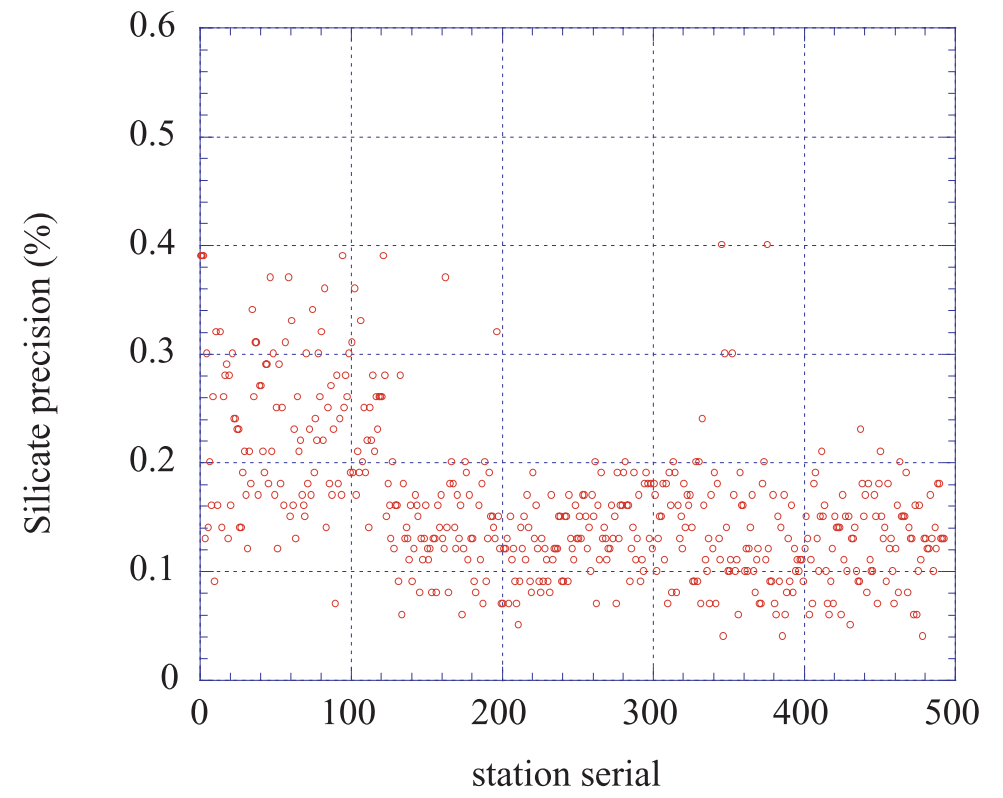

Figure 3.4.7. Time series of precision of silicate.

b. Carry over

We can also summarize the magnitudes of carry over throughout the cruise. These are as shown in Table 3.4.6. The average of carry over for nitrate was 0.45, which is relatively high rather than those of Phosphate and Silicate.

Table 3.4.6. Summary of carry over through out cruise.

	Nitrate	Phosphate	Silicate
	CV%	CV%	CV%
Median	0.49	0.20	0.12
Mean	0.48	0.20	0.10
Maximum	0.94	1.25	0.47
Minimum	0.03	0.00	0.00
N	491	491	491

c. Concentrations of low nutrients seawater

Concentrations of low nutrients seawater obtained from each measurement were summarized in Table 3.4.7. As shown in Table 3.4.7, the concentrations of low nutrients seawater used in this cruise are well reproduced against nominal concentrations given in May 2003. The phosphate concentration of low nutrients seawater was calculated as $0.15 \mu\text{mol kg}^{-1}$ while nominal concentration was $0.16 \mu\text{mol kg}^{-1}$. This discrepancy might be caused by the difference of automated decision process of peak positions of baseline between “base” and others. Then, we concluded that this difference as shown in Table 3.4.7 will not affect on the samples.

Table 3.4.7. Summary of low nutrients seawater through out cruise.

	Nitrate	Phosphate	Silicate
	micro mol kg-1	micro mol kg-1	micro mol kg-1
Median	0.01	0.15	0.99
Mean	0.01	0.15	0.98
Maximum	0.15	0.35	1.36
Minimum	-0.13	0.08	0.01
Nominal	0.00	0.16	1.01

The numbers of analysis were 490 for three parameters.

(6) Evaluation of trueness of nutrients concentrations using RMNSs

We have been using RMNS for all runs, then, we can evaluate the trueness of nutrients concentration throughout cruise. Results of RMNS measurements are shown in Figures 3.4.8-3.4.13.

The uncertainties of nitrate, phosphate and silicate measurements for this cruise were evaluated as functions of concentrations of those. Uncertainties of nitrate measurement are expressed by equation (1).

$$\text{Uncertainties (\%)} = 0.28 + 3.28 / \text{Cnitrate} \quad (1)$$

Where Cnitrate is nitrate concentration in $\mu\text{mol kg}^{-1}$.

Uncertainties of phosphate measurement are expressed equation (2).

$$\text{Uncertainties (\%)} = 0.26 + 0.942 / \text{Cphos} + 0.125 / (\text{Cphos} \times \text{Cphos}) \quad (2)$$

Where Cphos is phosphate concentration in $\mu\text{mol kg}^{-1}$.

Uncertainties of silicate measurement are expressed equation (3).

$$\text{Uncertainties (\%)} = 0.22 + 11.9 / \text{Csilicate} \quad (3)$$

Where Csilicate is silicate concentration in $\mu\text{mol kg}^{-1}$.

Then, we add new three columns to show the uncertainties of nutrients measurement in the sea file of this cruise.

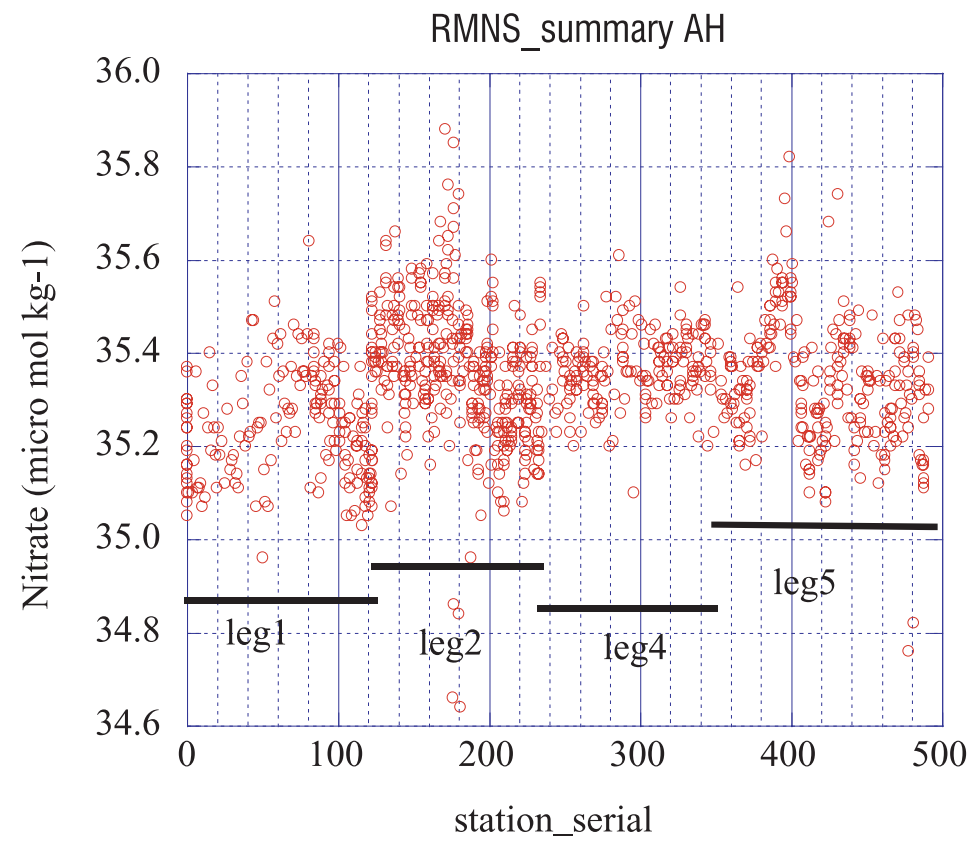

Figure 3.4.8. Time series of nitrate concentration for RMNS lot AH ordered as measurement.

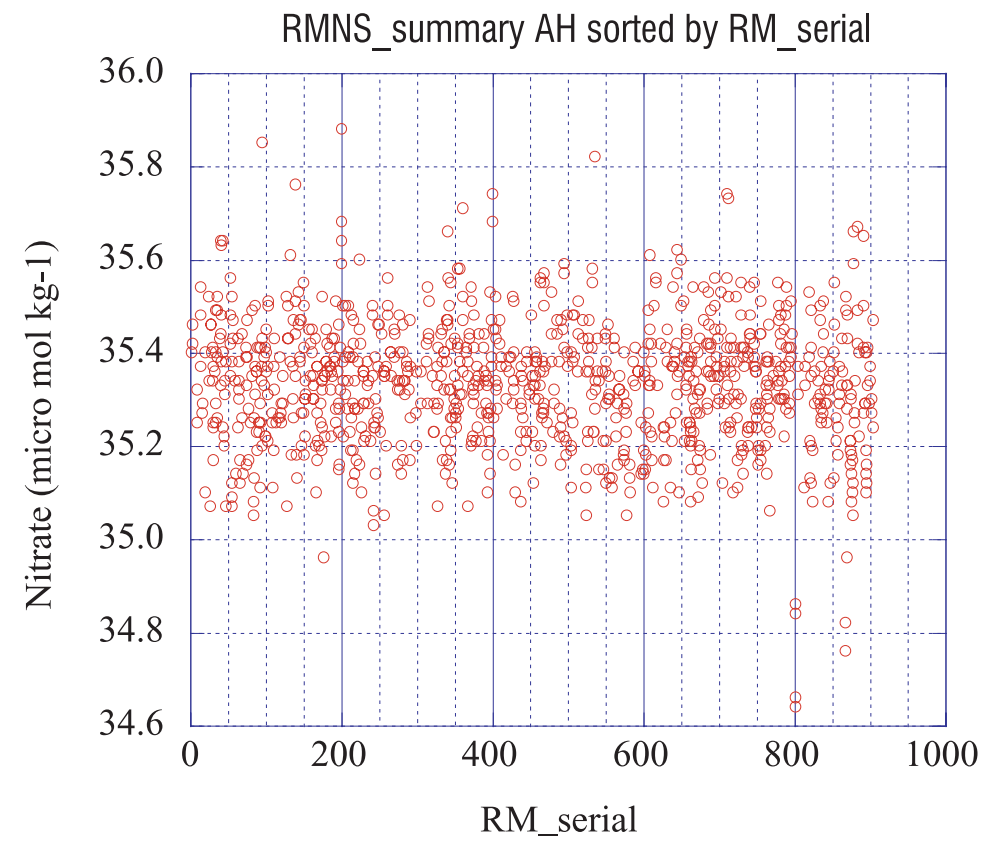

Figure 3.4.9. Time series of nitrate concentration for RMNS lot AH sorted by RMNS serial number.

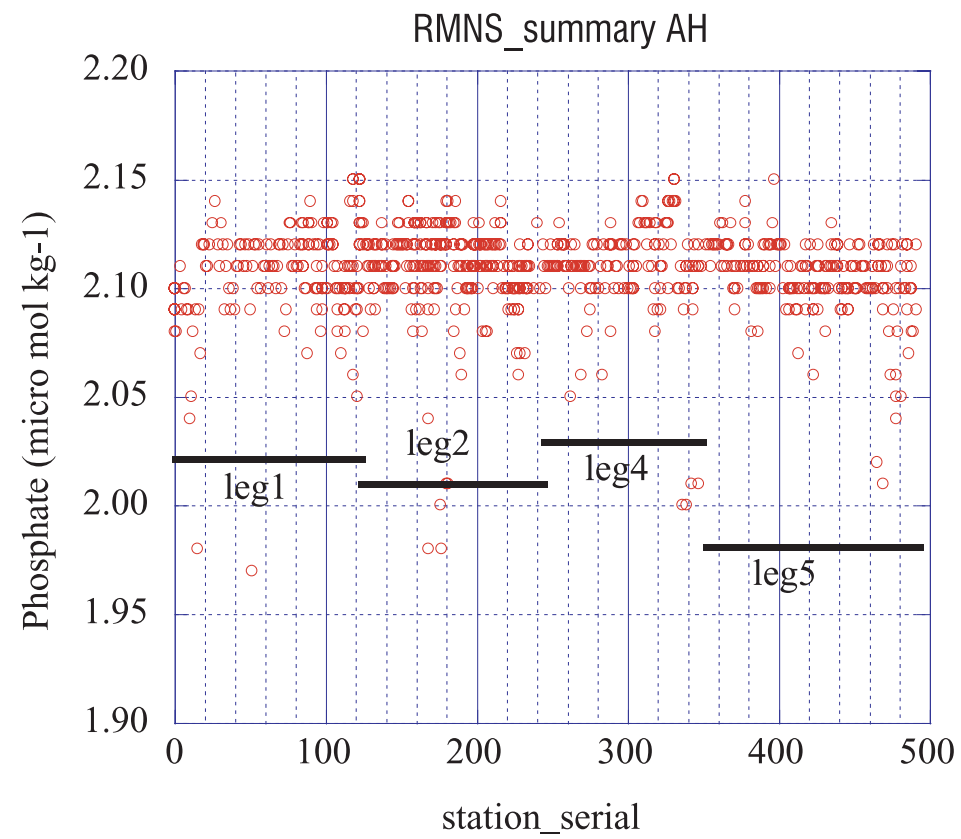

Figure 3.4.10. Same as Figure 3.4.8, but for phosphate.

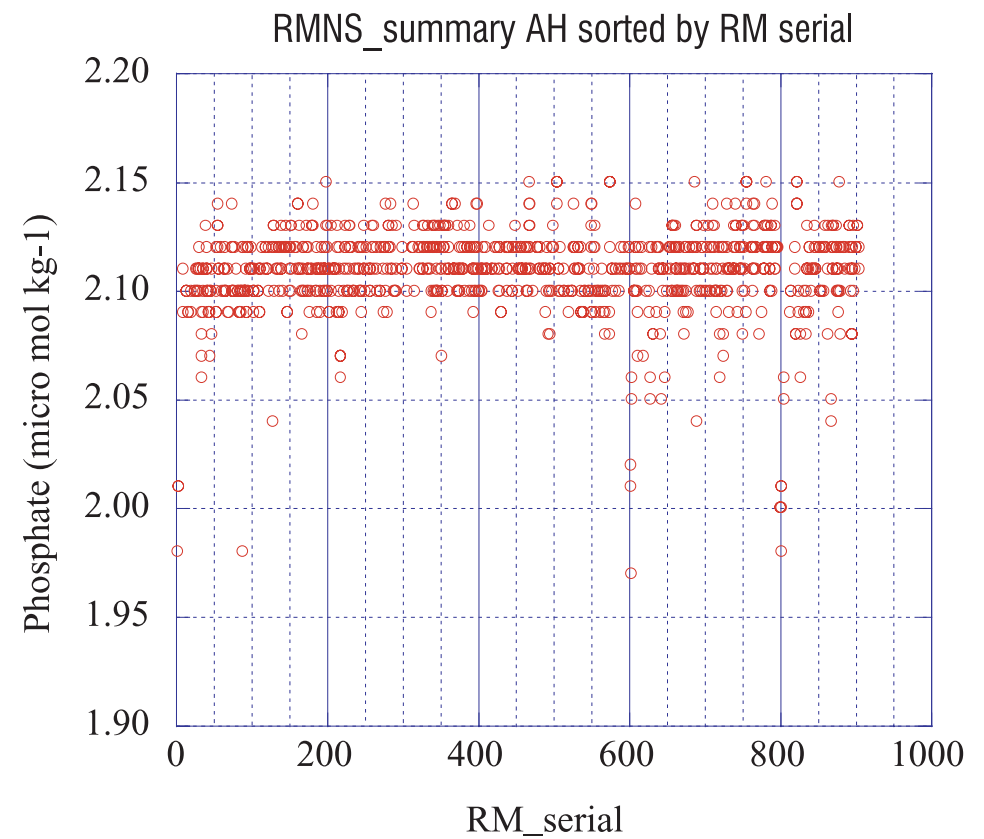

Figure 3.4.11. Same as Figure 3.4.9, but for phosphate.

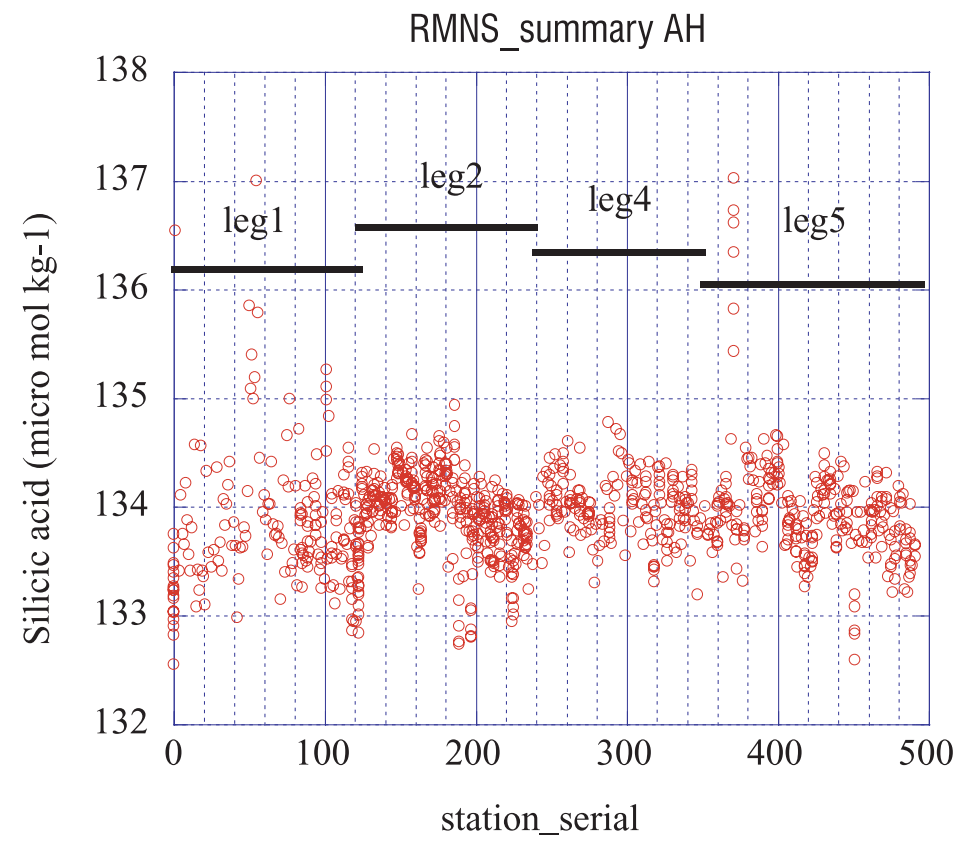

Figure 3.4.12. Same as Figure 3.4.8, but for silicic acid.

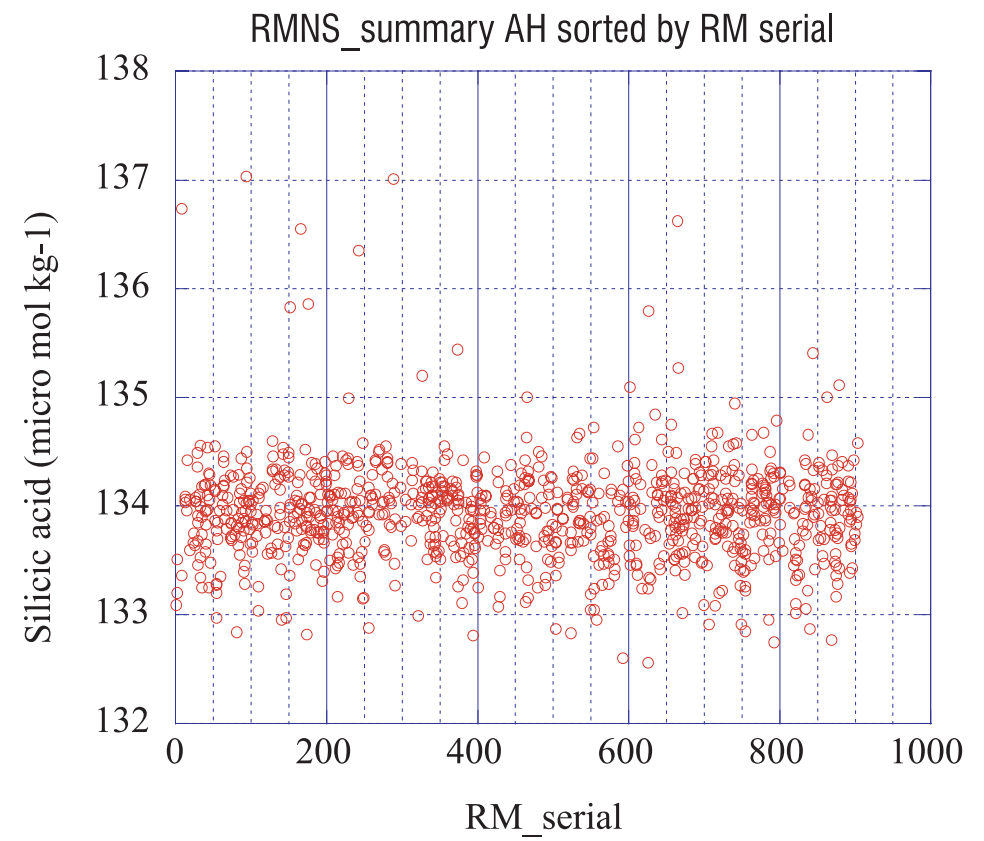

Figure 3.4.13. Same as Figure 3.4.9, but for silicic acid.

(7) Leg-to-leg traceability

Leg-to-leg traceability was examined based on the results of the statistics of RMNS-AH concentrations. As shown in Table 3.4.8 and 3.4.9, the medians and averages of the nutrients concentration of RMNS-AH were in good agreement among leg 1, 2, 4 and 5. The deviations among four legs were less than 0.3 % for nitrate, 0.2 % for silicate and 0 % for phosphate, respectively.

Table 3.4.8. Results of the statistics of RMNS-AH concentrations.

	NO3_Pacific	SiO2_Pacific	PO4_Pacific
median	35.33	133.95	2.11
mean	35.32	133.94	2.11
stdev	0.15	0.45	0.02
CV%	0.42	0.34	1.00
max	35.88	137	2.15
min	34.64	132.74	1.97
max-min	1.24	4.26	0.18
count	537	535	535

	NO3_Leg 1	SiO2_Leg 1	PO4_Leg 1
median	35.25	133.75	2.11
mean	35.25	133.88	2.11
stdev	0.12	0.62	0.02
CV%	0.33	0.46	1.13
max	35.64	137	2.15
min	34.96	132.86	1.97
max-min	0.68	4.14	0.18
count	166	165	165

	NO3_Leg 2	SiO2_Leg 2	PO4_Leg 2
median	35.37	134.00	2.11
mean	35.36	133.96	2.11
stdev	0.15	0.35	0.02
CV%	0.43	0.26	0.94
max	35.88	134.94	2.15
min	34.64	132.74	1.98
max-min	1.24	2.2	0.17
count	371	370	370

	NO3_Leg 4	SiO2_Leg 4	PO4_Leg 4
median	35.37	134.02	2.11
mean	35.37	134.02	2.11
stdev	0.07	0.30	0.02
CV%	0.21	0.23	1.02
max	35.61	134.90	2.15
min	35.10	133.19	2.00
max-min	0.51	1.71	0.15
count	181	183	183

	NO3_Leg 5	SiO2_Leg 5	PO4_Leg 5
median	35.34	133.93	2.11
average	35.34	133.95	2.11
stdev	0.13	0.51	0.02
cv%	0.38	0.38	1.14
max	35.82	137.02	2.39
min	34.76	131.99	2.01
max-min	1.06	5.03	0.38
count	267	267	267

Table 3.4.9. Summary of leg-to-leg traceability.

	Nitrate	Phosphate	Silicate
Leg 1	35.25	2.11	133.75
Leg 2	35.37	2.11	134.00
Leg 4	35.37	2.11	134.02
Leg 5	35.34	2.11	133.93

(8) Problems/improvements occurred and solutions

Leg 1

a. Silicate concentration decrease in 3-4 days in B-standard solution

A decrease of silicate concentration in B-standard solution was found three to four days after its renewal. This was found by the apparent change of RMNS-AH silicate concentrations.

We, then, decided to renew B-std solution of silicate every two days from the measurements of the sample at station P06C-166. We, also, did additional measurements of RM-AH to monitor the stability of B-std. After introducing this new procedure, the apparent stability of RMNS-AH silicate concentration becomes better.

b. Base line shift at 3 and 4 ch, silicate and phosphate channels, of #2 machine of TRAACS800

Base line shift at 3 and 4 ch, silicate and phosphate channels, of #2 machine of TRAACS800 were observed during leg 1. From station P06C-123, we had stopped to use #2 machine of TRAACS800. The measurements were continued using #1 machine of TRAACS800 until the station P06C-121.

At Tahiti, #2 machine of TRAACS800 were checked and a board and two cables were replaced.

c. Silicate concentration drift related with the direct flow from air conditioner in the laboratory

Silicate concentration drift related with the direct flow from air conditioner in the laboratory were observed in the results of #1 TRAACS. We, then, put temporally shield from the measurements of the sample at station P06C-160. The drift of the results of #1 TRAACS, however, did not become smaller after station P06X-160 during leg 1.

d. Nitrate concentration might decrease within a few weeks in A-standard solution after preparation

A decrease of nitrate concentration in A-standard solution was found within a few weeks after its renewal. This was found by the apparent change of RMNS-AH nitrate concentrations.

We, then, decided to renew A-std solution of nitrate every 10 days.

Leg 2

a. At Tahiti, a slave unit of #2 machine of TRAACS800 were checked and a board, a drive belt and two cables were replaced because baseline shift were occurred frequently at the end of leg 1

During the leg 2, baseline shift occurred few due to a same reason as that during leg 1 at the slave unit of #2 machine of TRAACS800, which were for silicate and phosphate. This might contribute an improvement of reproducibility of silicate analyses during leg 2, as shown in Table 3.4.8.

b. Decrease a reproducibility of nitrate analyses

Since the interval of pump tubes was relatively long rather than expected due to the heavy load of analyses, this might decrease the reproducibility of nitrate analyses. We also got a problem that air had invaded into sample lines through a four-way valve at a reduction column and it was replaced at station P06C-105.

c. Lower phosphate concentration for a few RMNS-AH bottles

We found that phosphate concentrations for 4 bottles of RM-AH during leg 2 were unreasonably low comparing the concentrations of RMNS bottles. Those are AH-34, 218, 802 and 895, respectively.

Leg 4

a. Lower phosphate concentration for a few RMNS-AH bottles

We found that phosphate concentrations for 4 bottles of RM-AH during leg 4 were unreasonably low comparing the concentrations of RMNS bottles. Those are AH-4, 720, 801 and 805, respectively.

b. Simultaneous base line shift at 3 and 4 ch, silicate and phosphate channels, of #2 machine of TRAACS800

Simultaneous base line shift at 3 and 4 ch, silicate and phosphate channels, of #2 machine of TRAACS800 were occurred seven times during leg 4. Although, #2 machine of TRAACS800 were checked at Tahiti and a board, two cables and a drive belt were replaced and base line shift becomes less, these simultaneous base line shifts may be caused by different reason.

c. Preventive replacements of pump tubes and flow cells, and careful treatment of the peak position determination might contribute excellent results on analytical precision

We did preventive replacements of pump tubes before baseline noise would increase due to the aging of pump tubes. We also did preventive replacements of flow cells to maintain good condition of the TRAACS800s.

We pay more attention to determine peak positions before the calculation of concentrations of nutrients.

Leg 5

a. Silicate TRAACS800s #1 #2 systematic difference between two machines about 0.7 %

b. Pump tube replacement interval ca. 5days same as leg 4 lead better precision

c. A pump and a drive belt for ch3, ch4 were replaced prior leg 5, then, no shift occurred during leg 5

References

Aminot, A. and R. Kerouel, 1991, Autoclaved seawater as a reference material for the determination of nitrate and phosphate in seawater, *Anal. Chim. Acta*, 248 : 277-283.

Aminot, A. and D.S. Kirkwood, 1995, Report on the results of the fifth ICES intercomparison exercise for nutrients in sea water, *ICES coop. Res. Rep. Ser.*, 213.

Aminot, A. and R. Kerouel, 1995, Reference material for nutrients in seawater : stability of nitrate, nitrite, ammonia and phosphate in autoclaved samples. *Mar. Chem.*, 49 : 221-232.

Aoyama, M. and T.M. Joyce, 1996, WHP property comparisons from crossing lines in North Pacific. In *Abstracts, 1996 WOCE Pacific Workshop*, Newport Beach, California.

Aoyama, M., H. Ota, S. Iwano, H. Kamiya, M. Kimura, S. Masuda, N. Nagai, K. Saito and H. Tubota, 2004, Reference material for nutrients in seawater in a seawater matrix, *Mar. Chem.*, submitted.

Grasshoff, K., M. Ehrhardt, K. Kremling et al., 1983, *Methods of seawater analysis*. 2nd ref. ed. Verlag Chemie GmbH, Weinheim. 419.

Joyce, T. and C. Corry, 1994, Requirements for WOCE hydrographic programmed data reporting. *WHPO*

Publication, 90-1, Revision 2, WOCE Report No. 67/91.

Kirkwood, D.S., 1992, Stability of solutions of nutrient salts during storage. *Mar. Chem.*, 38 : 151-164.

Kirkwood, D.S., A. Aminot and M. Perttala, 1991, Report on the results of the ICES fourth intercomparison exercise for nutrients in sea water. ICES coop. Res. Rep. Ser., 174.

Mordy, C.W., M. Aoyama, L.I. Gordon, G.C. Johnson, R.M. Key, A.A. Ross, J.C. Jennings and J. Wilson, 2000, Deep water comparison studies of the Pacific WOCE nutrient data set. *Eos Trans-American Geophysical Union*. 80 (supplement), OS43.

Murphy, J. and J.P. Riley, 1962, *Analytica chim. Acta* 27, 31-36.

Gouretski, V.V. and K. Jancke, 2001, Systematic errors as the cause for an apparent deep water property variability: global analysis of the WOCE and historical hydrographic data, REVIEW ARTICLE, *Progress In Oceanography*, 48 : Issue 4, 337-402.

3.5 Dissolved inorganic carbon (C_T)

5 February 2005

(1) Personnel

Akihiko Murata (IORGC, JAMSTEC)

Mikio Kitada (MWJ)

Minoru Kamata (MWJ)

Masaki Moro (MWJ)

Toru Fujiki (MWJ)

(2) Introduction

Concentrations of CO_2 in the atmosphere are now increasing at a rate of 1.5 ppmv y^{-1} due to human activities such as burning of fossil fuels, deforestation, cement production, etc. It is an urgent task to estimate as accurately as possible the absorption capacity of the oceans against the increased atmospheric CO_2 , and to clarify the mechanism of the CO_2 absorption, because the magnitude of the predicted global warming depends on the levels of CO_2 in the atmosphere, and because the ocean currently absorbs 1/3 of the 6 Gt of carbon emitted into the atmosphere each year by human activities.

In this cruise (BEAGLE), we were aimed at quantifying how much anthropogenic CO_2 absorbed in the Southern Ocean, where intermediate and deep waters are formed, are transported and redistributed in the southern hemisphere subtropical oceans. For the purpose, we measured CO_2 -system properties such as dissolved inorganic carbon (C_T), total alkalinity (A_T), pH and underway pCO_2 .

In this section, we describe data on C_T obtained in the BEAGLE in detail.

(3) Apparatus

Measurements of C_T were made with two total CO_2 measuring systems (systems A and B; Nippon ANS,

Inc.), which are slightly different from each other. The systems comprise of a seawater dispensing system, a CO_2 extraction system and a coulometer (Model 5012, UIC Inc.).

The seawater dispensing system has an auto-sampler (6 ports), which takes seawater in a 300 ml borosilicate glass bottle and dispenses the seawater to a pipette of nominal 20 ml volume by a PC control. The pipette is kept at $20 \text{ }^\circ\text{C}$ by a water jacket, in which water from a water bath set at $20 \text{ }^\circ\text{C}$ is circulated.

CO_2 dissolved in a seawater sample is extracted in a stripping chamber of the CO_2 extraction system by adding phosphoric acid (10 % v/v). The stripping chamber is approx. 25 cm long and has a fine frit at the bottom. To degas CO_2 as quickly as possible, a heating wire kept at $40 \text{ }^\circ\text{C}$ was rolled from the bottom to a 1/3 height of the stripping chamber. The acid is added to the stripping chamber from the bottom of the chamber by pressurizing an acid bottle for a given time to push out the right amount of acid. The pressurizing is made with nitrogen gas (99.9999 %). After the acid is transferred to the stripping chamber, a seawater sample kept in a pipette is introduced to the stripping chamber by the same method as in adding an acid. The seawater reacted with phosphoric acid is stripped of CO_2 by bubbling the nitrogen gas through a fine frit at the bottom of the stripping chamber. The CO_2 stripped in the stripping chamber is carried by the nitrogen gas (flow rates of 130 ml min^{-1} and 140 ml min^{-1} for the systems A and B, respectively) to the coulometer through a dehydrating module. For the system A, the module consists of two electric dehumidifiers (kept at $1 - 2 \text{ }^\circ\text{C}$) and a chemical desiccant ($Mg(ClO_4)_2$). For the system B, it consists of three electric dehumidifiers with a chemical desiccant.

(4) Shipboard measurement

Sampling

All seawater samples were collected from depth with 12 liter Niskin bottles basically at every other stations. The seawater samples for C_T were taken with a plastic drawing tube (PFA tubing connected to silicone rubber tubing) into a 300 ml borosilicate glass bottle. The glass bottle was filled with seawater smoothly from the bottom following a rinse with a seawater of 2 full, bottle volumes. The glass bottle was closed by a stopper, which was fitted to the bottle mouth gravimetrically without additional force.

At a chemical laboratory on the ship, a headspace of approx. 1 % of the bottle volume was made by removing seawater using a plastic pipette. A saturated mercuric chloride of 100 μ l was added to poison seawater samples. The glass bottles were sealed with a greased (Apiezon M, M&I Materials Ltd) ground glass stopper and the clips were secured. The seawater samples were kept at 4 °C in a refrigerator until analysis. A few hours just before analysis, the seawater samples were kept at 20 °C in a water bath.

Analysis

At the start of each leg, we calibrated the measuring systems by blank and 5 kinds of Na₂CO₃ solutions (nominally 500, 1000, 1500, 2000, 2500 μ mol/L). As it was empirically known that coulometers do not show a stable signal (low repeatability) with fresh (low absorption of carbon) coulometer solutions. Therefore we measured 2 % CO₂ gas repeatedly until the measurements became stable. Then we started the calibration.

The measurement sequence such as system blank (phosphoric acid blank), 2 % CO₂ gas in a nitrogen base, seawater samples (6) was programmed to repeat. The measurement of 2 % CO₂ gas was made to monitor response of coulometer solutions (from UIC, Inc.). For every renewal of coulometer solutions, certified reference materials (CRM, batch 60) provided by Prof. A. G. Dickson of Scripps Institution of Oceanography were analyzed. In addition, reference materials (RM) provided by JAMSTEC (2 kinds) and KANSO were measured at the initial, intermediate and end times of a coulometer solution's lifetime.

The preliminary values were reported in a data sheet on the ship. Repeatability and vertical profiles of C_T based on raw data for each station helped us check performances of the measuring systems.

In each leg, we finished all the analyses for C_T on board the ship. As we used two systems, we had not encountered such a situation as we had to abandon the measurement. However, we experienced some malfunctions of the measuring systems during the cruise, which are described in the followings:

In the leg 1, due to malfunction of the coulometer of the system B, we replaced it to a back-up coulometer;

There occurred lowering of repeatability, mostly due to dirt. This situation was recovered by cleaning the measuring systems;

The "undershooting" of coulometer detection was often found. This happened in measuring seawater samples subsequent to the measurement of phosphoric acid blank. To avoid the "undershooting" occurred in seawater sample measurement, we measured a dummy seawater sample subsequent to the blank measurement.

(5) Quality control

Leg 1

Calibration factors of the systems A and B were listed in Table 3.5.1. With these factors, we calculated C_T of CRM (batch 60), and plotted the values as a function of sequential day (Fig. 3.5.1). From Fig. 3.5.1, it is found that there were no trends of CRM measurements for the system A during the leg 1. The average and standard deviation were 1991.0 and 1.5 μ mol kg⁻¹ (n = 40), respectively. Since the certified value of the batch 60 is 1991.24 μ mol kg⁻¹, very close to the average, it implies that the measurement had been conducted in a good condition.

For the system B, however, we had to replace the coulometer with a back-up one, because repeatability for the system B had been worse (3.0 μ mol kg⁻¹ for CRM measurements) than usually expected value (~1.5 μ mol kg⁻¹). Before and after the replacement, the calibration factor changed largely from 0.31322 to 0.31644 (Table 3.5.1). This change of a calibration factor caused CRM measurements to be 2011.7 \pm 1.5 μ mol kg⁻¹, which were 1991.9 μ mol kg⁻¹ before the replacement.

Based on the results of CRM measurements stated above, we re-calculated the calibration factors so that measurements of seawater samples become traceable to the certified value of batch 60. For example, the initial factor of 0.31322 for the system A became 0.31333 by such a calculation as 0.31322/(1990.24/1991.0).

Temporal variations of RM measurements are shown in Fig. 3.5.2. From Fig. 3.5.2, it is evident that RM measurements included a linear trend, implying that measurements of seawater samples also have the trend. The trend was also found in temporal changes of 2 % CO₂ gas measurements. The trend seems to be due to "cell age" change (Johnson et al., 1998) of a coulometer solution.

Considering the trends, we adjusted measurements of seawater samples so as to be traceable to the certified

value of batch 60, although the adjustments were usually slight.

Finally we surveyed vertical profiles of C_T . In particular, we examined whether systematic differences between measurements of the systems A and B existed or not. Then taking other information of analyses into account, we determined a flag of each value of C_T .

The average and standard deviation of absolute values of differences of C_T analyzed consecutively were 1.5 and $1.3 \mu\text{mol kg}^{-1}$ ($n = 203$), respectively.

Leg 2

Calibration factors of the systems A and B for the leg 2 are listed in Table 3.5.1, and temporal variations of CRM C_T are shown in Fig. 3.5.3.

From Fig. 3.5.3, it is found that the CRM C_T for the system A changes discontinuously at the 268th sequential day. In the former period, no trends are found, while in the latter period, a significant trend exists. We do not know the causes of this discontinuity and the subsequent trend. For the system B, no such a variation of CRM C_T is found (Fig. 3.5.3).

The average and standard deviation of CRM C_T in the former period (before the 268 sequential day) for the system A were calculated to be 1990.9 and $1.2 \mu\text{mol kg}^{-1}$ ($n = 16$), respectively. Those in the latter period were 1990.7 and $1.4 \mu\text{mol kg}^{-1}$ ($n = 20$), respectively. For the system B, the average and standard deviation were 1994.1 and $1.9 \mu\text{mol kg}^{-1}$ ($n = 34$), respectively.

Based on the information of CRM C_T stated above, we re-calculated the calibration factors as made for the leg 1, considering the trend.

Based on RM measurements, we adjusted the trend of C_T of seawater samples as conducted for the data on leg 1. Then, we checked the vertical profiles of C_T , and determined a flag of each C_T value.

The average and standard deviation of absolute values of differences of C_T analyzed consecutively were 1.5 and $1.4 \mu\text{mol kg}^{-1}$ ($n = 188$), respectively.

Leg 4

Calibration factors of the systems A and B for the leg 4 are listed in Table 3.5.1, and temporal variations of CRM C_T are shown in Fig. 3.5.4.

From Fig. 3.5.4, it is found that there existed no trends for the system A, but a slight decreasing trend for the system B, which was not significant statistically.

The average and standard deviation of CRM C_T for the system A were 1988.2 and $1.1 \mu\text{mol kg}^{-1}$ ($n = 35$), respectively, while those for the system B were 1998.6 and $0.9 \mu\text{mol kg}^{-1}$ ($n = 28$), respectively.

Based on the information of CRM C_T stated above, we re-calculated the calibration factors as made for the leg 1.

Based on RM measurements, we adjusted the trend of C_T of seawater samples as conducted for the data on leg 1. Then, we checked the vertical profiles of C_T , and determined a flag of each C_T value.

The average and standard deviation of absolute values of differences of C_T analyzed consecutively were 1.0 and $0.8 \mu\text{mol kg}^{-1}$ ($n = 166$), respectively.

Leg 5

Calibration factors of the systems A and B for the leg 5 are listed in Table 3.5.1, and temporal variations of CRM C_T are shown in Fig. 3.5.5. From this figure, it is found that for both the systems, the CRM C_T s show statistically significant increasing trends, but in a discontinuous manner. Therefore we divided the time series into the two periods. Then we calculated the averages and standard deviations of each period separately.

The average and standard deviation of CRM C_T for the former period (before the 367th sequential day) of the system A were 1989.7 and $1.3 \mu\text{mol kg}^{-1}$ ($n = 25$), respectively, while those for the latter period were 1990.1 and $1.0 \mu\text{mol kg}^{-1}$ ($n = 17$), respectively. For the system B, the average and standard deviation for the former period (before 377th sequential day) were 1988.6 and $0.9 \mu\text{mol kg}^{-1}$ ($n = 29$), respectively, while those for the latter period were 1990.1 and $0.5 \mu\text{mol kg}^{-1}$ ($n = 6$), respectively.

Based on RM measurements, we adjusted the trend of C_T of seawater samples as conducted for the data on

leg 1. Then, we checked the vertical profiles of C_T , and determined a flag of each C_T value.

The average and standard deviation of absolute values of differences of C_T analyzed consecutively were 0.9 and $0.7 \mu\text{mol kg}^{-1}$ ($n = 229$), respectively.

Reference

Johnson, K.M., A.G. Dickson, G. Eiseid, C. Goyet, P. Guenther, R.M. Key, F. J. Millero, D. Purkerson, C.L.

Sabine, R.G. Schottle, D.W.R. Wallace, R.J. Wilke and C.D. Winn (1998): Coulometric total carbon dioxide analysis for marine studies: assessment of the quality of total inorganic carbon measurements made during the US Indian Ocean CO_2 survey 1994-1996, Mar. Chem., 63, 21-37.

Table 3.5.1. Calibration factors determined from Na_2CO_3 solutions.

Leg no.	Calibration factors		Remarks
	A	B	
1	0.31322	0.31322	Replacement of coulometer was conducted for the system B.
		0.31644	
2	0.31281	0.31589	
4	0.31399	0.30895	
5	0.31398	0.31140	

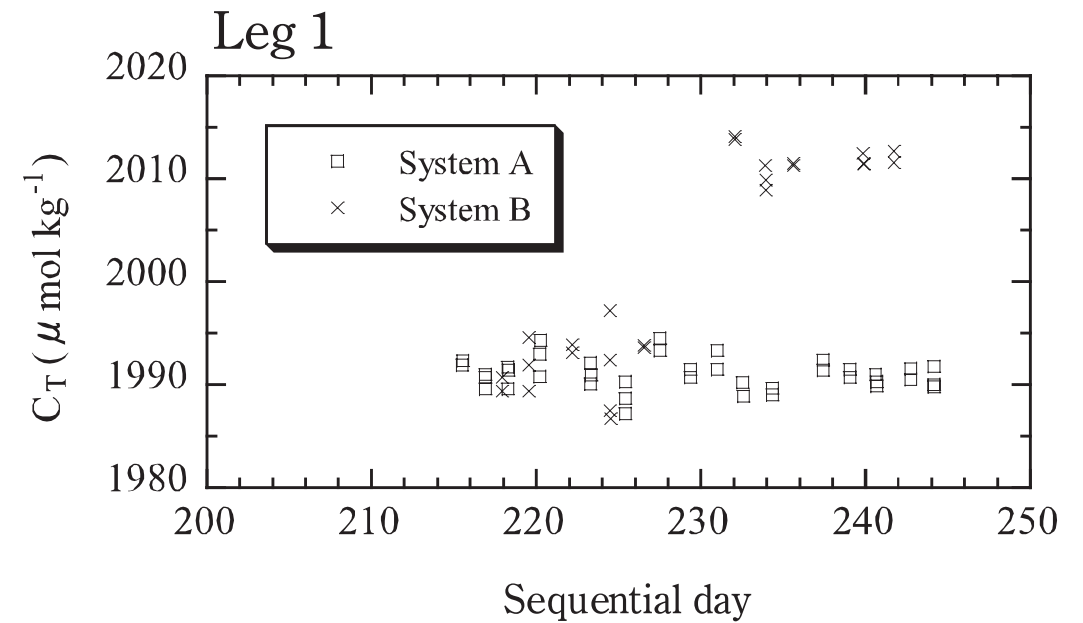

Figure 3.5.1. Temporal variations of CRM C_T measured by the systems A and B in the leg 1.

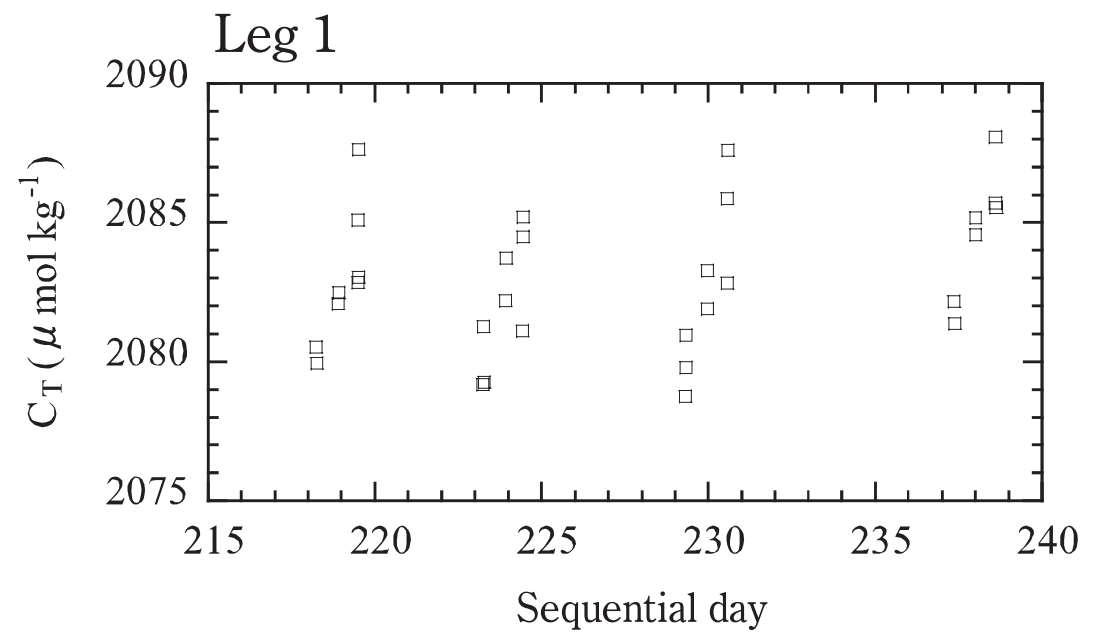

Figure 3.5.2. An example of temporal variations of RM C_T .

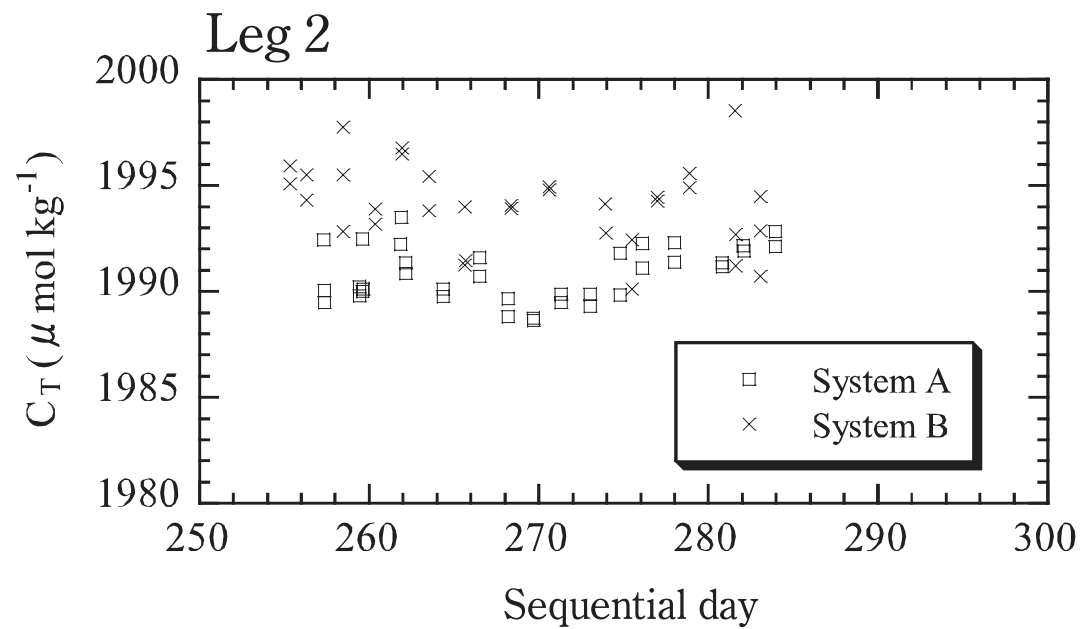

Figure 3.5.3. Temporal variations of CRM C_T measured by the systems A and B in the leg 2.

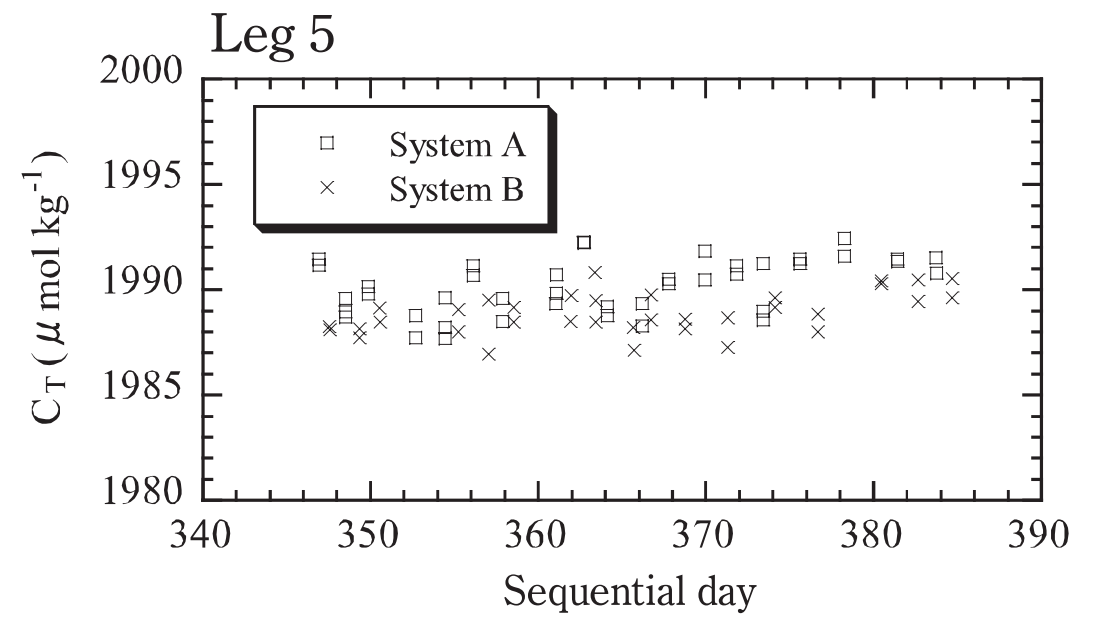

Figure 3.5.5. Temporal variations of CRM C_T measured by the systems A and B in the leg 5.

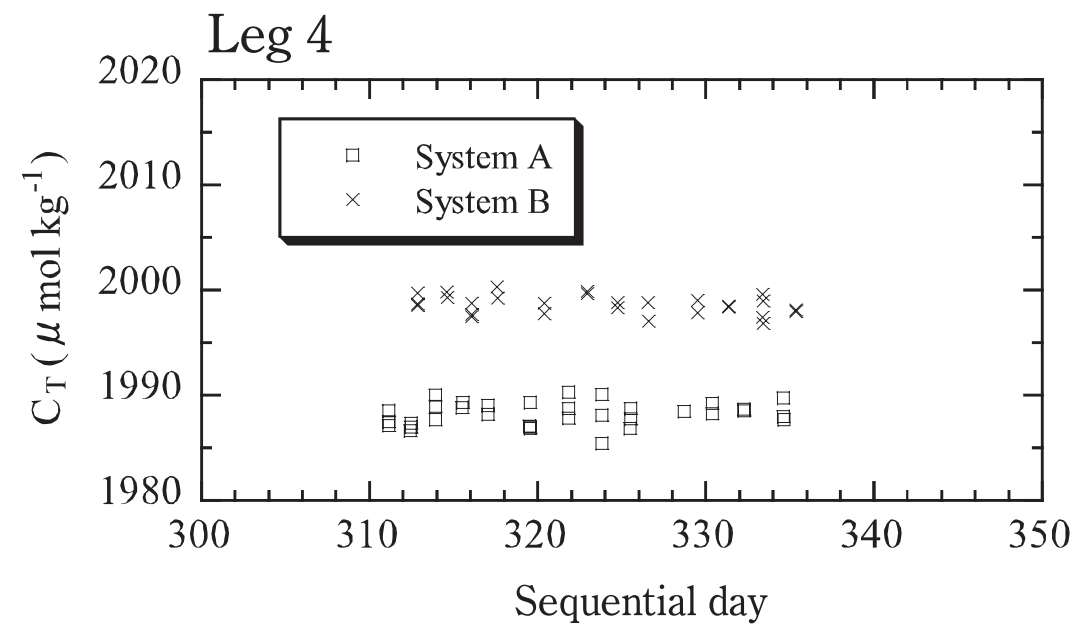

Figure 3.5.4. Temporal variations of CRM C_T measured by the systems A and B in the leg 4.

3.6 Total alkalinity (A_T)

3 February 2005

(1) Personnel

Akihiko Murata (IORGC, JAMSTEC)

Fuyuki Shibata (MWJ)

Taeko Ohama (MWJ)

(2) Introduction

Concentrations of CO_2 in the atmosphere are now increasing at a rate of 1.5 ppmv y^{-1} due to human activities such as burning of fossil fuels, deforestation, cement production, etc. It is an urgent task to estimate as accurately as possible the absorption capacity of the oceans against the increased atmospheric CO_2 , and to clarify the mechanism of the CO_2 absorption, because the magnitude of the predicted global warming depends on the levels of CO_2 in the atmosphere, and because the ocean currently absorbs 1/3 of the 6 Gt of carbon emitted into the atmosphere each year by human activities.

In the BEAGLE, we were aimed at quantifying how much anthropogenic CO_2 absorbed in the Southern Ocean, where intermediate and deep waters are formed, are transported and redistributed in the southern hemisphere subtropical oceans. For the purpose, we measured CO_2 -system properties such as dissolved inorganic carbon (C_T), total alkalinity (A_T), pH and underway pCO_2 .

In this section, we describe data on A_T obtained in the BEAGLE in detail.

(3) Apparatus

The measuring system for A_T (customized by Nippon ANS, Inc.) comprises of a water dispensing unit with an auto-sampler (6 ports), an auto-burette (Metrohm) and a pH meter (Thermo Orion). They are automatically controlled by a PC. We prepared two systems for the BEAGLE, but a single system was enough

for the measurement except for the leg 1, because the system could perform a high speed titration (5-6 min.).

Combined electrodes (Model 8103BN ROSS™) were used through the cruise.

A seawater of approx. 40 ml is transferred from a sample bottle (borosilicate glass bottle; 130 ml) into a water-jacketed (25 °C) pipette by pressurized N_2 gas, and is introduced into a water-jacketed (25 °C) titration cell. Next, a given volume of a titrant is injected into the titration cell so that pH of a seawater sample becomes 4.5 – 4.0. The seawater sample mixed with the titrant is stirred for three minutes by a stirring chip. Then an aliquot of titrant (~0.1 ml) is added consecutively until pH or e.m.f. reaches a given value. The concentration of the acid titrant is nominally 0.05 M HCl in 0.65 M NaCl.

Calculation of A_T is made based on a modified Gran approach.

(4) Shipboard measurement

Sampling

All seawater samples were collected from depth using 12 liter Niskin bottles basically at every other stations. The seawater samples for A_T were taken with a plastic drawing tube (PFA tubing connected to silicone rubber tubing) into borosilicate glass bottles of 130 ml. The glass bottle was filled with seawater smoothly from the bottom after rinsing it with a seawater of half a or a full bottle volume. A few hours before analysis, the seawater samples were kept at 25 °C in a water bath.

Analysis

For the A_T measurement, we selected electrodes, which showed signals close to theoretical Nernstian behavior.

At the start of each leg, we conducted calibration of the acid titrant, which was prepared on land. The calibration was made by measuring A_T of 5 solutions of Na_2CO_3 in 0.7 M NaCl solutions (nominally 0, 100, 1000, 2000 and 2500 $\mu\text{mol kg}^{-1}$). The measured values of A_T (calculated by assuming 0.05 M acid titrant) should be a linear function of the A_T computed from concentrations of the Na_2CO_3 solutions. The linear function was fitted by

the method of least squares. Theoretically, the slope of the linear function should be unity. If the measured slope is not equal to one, the acid normality should be adjusted by dividing initial normality by the slope, and the whole set of calculations is repeated until the slope = 1.

Before starting analyses of seawater samples, we measured A_T of dummy seawater samples to confirm a condition of the measuring systems. If repeat measurements of A_T were constant within $\sim 3 \mu\text{mol kg}^{-1}$, we initiated measurement of seawater samples. We analyzed reference materials (RM), which were produced for C_T by JAMSTEC and KANSO, but were efficient also for the monitor of A_T measurement. In addition, certified reference materials (CRM, batch 60, certified value = $2199.55 \mu\text{mol kg}^{-1}$) were also analyzed periodically to monitor systematic differences of measured A_T .

The preliminary values were reported in a data sheet on the ship. Repeatability calculated from replicate samples and vertical profiles of A_T based on raw data for each station helped us check performances of the measuring systems.

In each leg, we finished all the analyses for A_T on board the ship. We did not encounter so serious a problem as we had to give up the analyses. However, we experienced some malfunction of the system during the cruise, which are listed in the followings:

Small bubbles were often found in a pipette, probably due to stagnation of a seawater flow in the joint at an inlet of a pipette. In this case, we re-sealed the joint properly;

After analyses of a large number of samples, we often experienced a drift of an electrode, which appeared as differences of pH or e.m.f. in spite of an injection of a constant volume of an acid titrant into a seawater sample of almost a same A_T . In this case, we changed ranges of pH or e.m.f. used for the determination of A_T .

(5) Quality control

Leg 1

We used two systems (systems A and B) in this leg, but about 2/3 of the all the samples were analyzed by the system A.

Temporal variations of CRM A_T are displayed in Fig. 3.6.1. From this figure, it is found that for both the systems, such characteristic patterns as trend, discontinuity, etc. do not exist in the variations. Therefore, we re-calculated A_T of seawater samples using the concentration of HCl, which was re-calculated from the average of measured CRM A_T and the certified value of CRM A_T .

We surveyed vertical profiles of A_T . In particular, we examined whether systematic differences between measurements of the systems A and B existed or not. Then taking other information of analyses into account, we determined a flag of each value of A_T .

The average and standard deviation of absolute values of differences of A_T analyzed consecutively were 2.2 and $1.8 \mu\text{mol kg}^{-1}$ ($n = 188$), respectively.

We compared A_T measured in the BEAGLE with A_T calculated from C_T and $p\text{CO}_2$ measured in the WOCE P6 (Fig. 3.6.5). We judged that differences of A_T between the two observation periods are due to analytical errors, because the differences are also found in the deep layer.

Leg 2

We analyzed all seawater samples by the system B.

Temporal variations of CRM A_T are displayed in Fig. 3.6.2. From this figure, it is found that there exists a decreasing trend of A_T . In addition, we also found some gaps of measured A_T , when we examined the vertical profiles of A_T . Considering these results, we decided to calculate averages of CRM A_T separating the data into three periods. Since in the first period (before the 270th sequential day, Fig. 3.6.2), the A_T includes a decreasing trend, we determined the values of CRM A_T at each sequential day of measurements of seawater samples considering the trend. Then we determined concentration of HCl from the corrected values of CRM A_T and the certified value of CRM A_T .

We surveyed vertical profiles of A_T . Then taking other information of analyses into account, we determined a flag of each value of A_T .

The average and standard deviation of absolute values of differences of A_T analyzed consecutively were 2.5

and $2.0 \mu\text{mol kg}^{-1}$ ($n = 168$), respectively.

We compared A_T measured in the BEAGLE with A_T calculated from C_T and $p\text{CO}_2$ measured in the WOCE P6 (Fig. 3.6.5). We judged that differences of A_T ($5 - 10 \mu\text{mol kg}^{-1}$) between the two observation periods are due to analytical errors, because the differences are also found in the deep layer.

Leg 4

We analyzed all seawater samples by the system B.

Temporal variations of CRM A_T are displayed in Fig. 3.6.3. From this figure, it is found that there exists a discontinuous change of A_T . That is, before the 320 sequential day, the A_T shows a decreasing trend, but after the day, the A_T displays a stationary variation. From this characteristics of temporal variation, we re-calculated concentrations of HCl, separating the data for CRM A_T into two periods, as conducted in the quality control for the leg 2.

We surveyed vertical profiles of A_T . Then taking other information of analyses into account, we determined a flag of each value of A_T .

The average and standard deviation of absolute values of differences of A_T analyzed consecutively were 2.2 and $1.7 \mu\text{mol kg}^{-1}$ ($n = 162$), respectively.

We compared A_T measured in the BEAGLE with A_T measured in the WOCE A10 (Fig. 3.6.6). We judged that differences of A_T ($5 - 10 \mu\text{mol kg}^{-1}$) between the two observation periods are due to analytical errors, except for the upper layer. The differences in the upper layer might be related to seasonal differences.

Leg 5

We analyzed all seawater samples by the system B.

Temporal variations of CRM A_T are displayed in Fig. 3.6.4. The A_T shows a decreasing trend. Therefore, we reflected the trend in re-determining concentration of HCl, as conducted in the quality control for the leg 2.

We surveyed vertical profiles of A_T . Then taking other information of analyses into account, we determined

a flag of each value of A_T .

The average and standard deviation of absolute values of differences of A_T analyzed consecutively were 2.0 and $1.8 \mu\text{mol kg}^{-1}$ ($n = 220$), respectively.

We compared A_T measured in the BEAGLE with A_T measured in the WOCE I3 and I4 (Fig. 3.6.7). It is evident that A_T s obtained in the BEAGLE are systematically lower by $5 - 10 \mu\text{mol kg}^{-1}$ than those in the WOCE. At present, we do not know the reason why such a difference occurs.

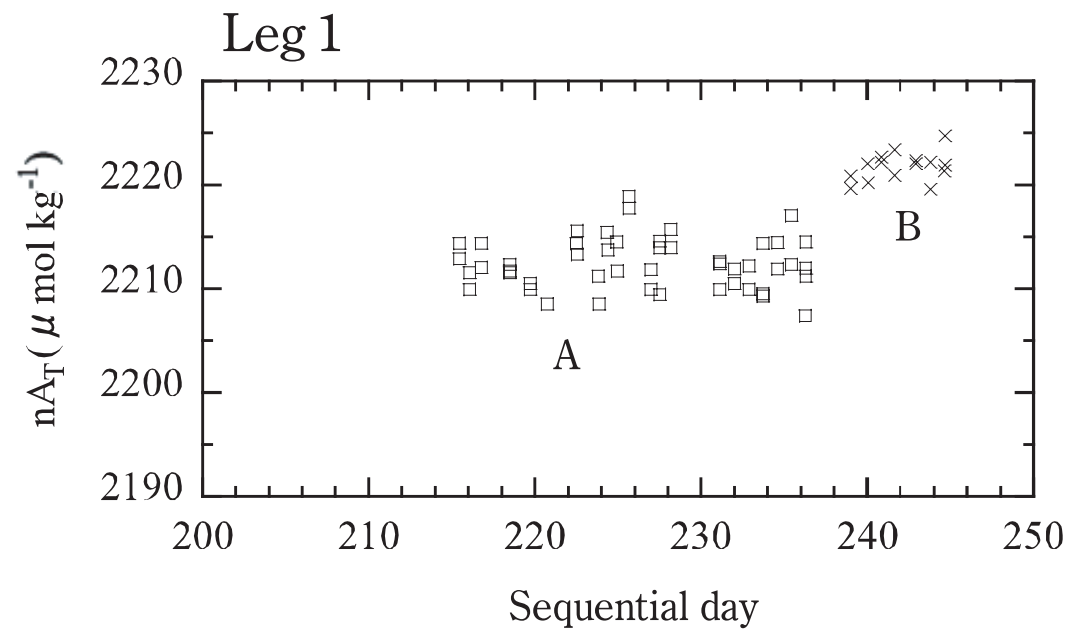

Figure 3.6.1. Temporal variations of CRM A_T measured in the leg 1. The sequential day is counted from 1 January, 2003. The "A" and "B" indicate results of the systems A and B, respectively.

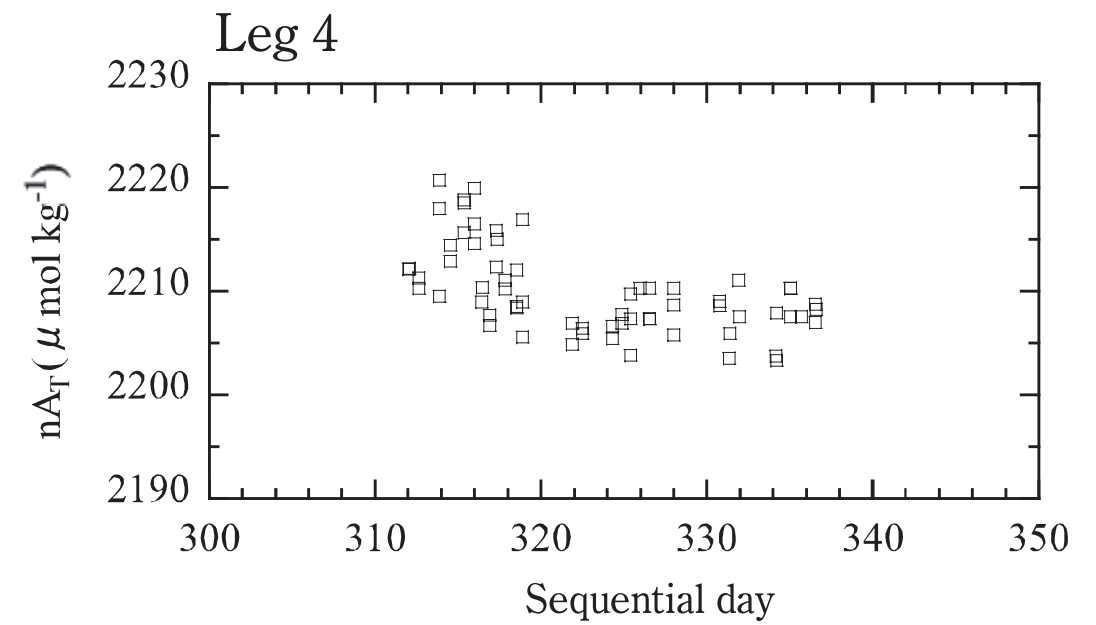

Figure 3.6.3. Temporal variations of CRM A_T measured in the leg 4.

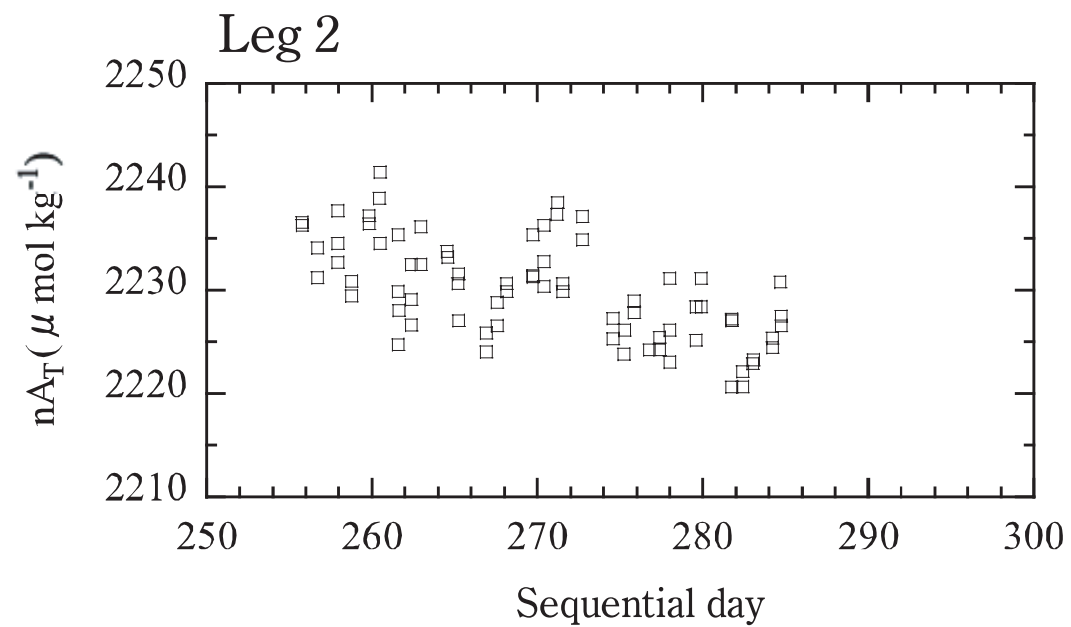

Figure 3.6.2. Temporal variations of CRM A_T measured in the leg 2.

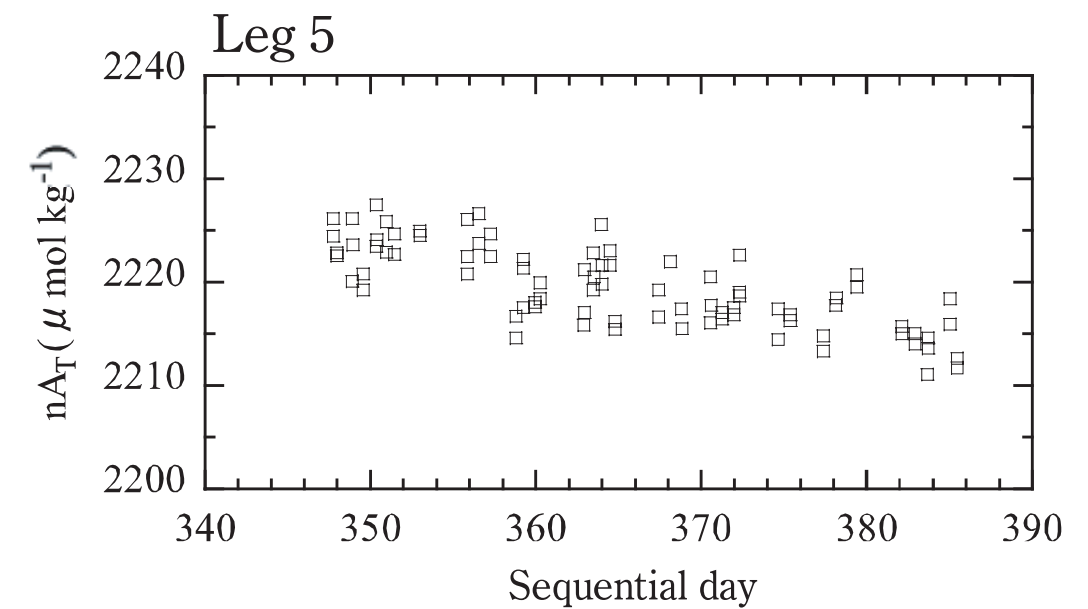

Figure 3.6.4. Temporal variations of CRM A_T measured in the leg 5.

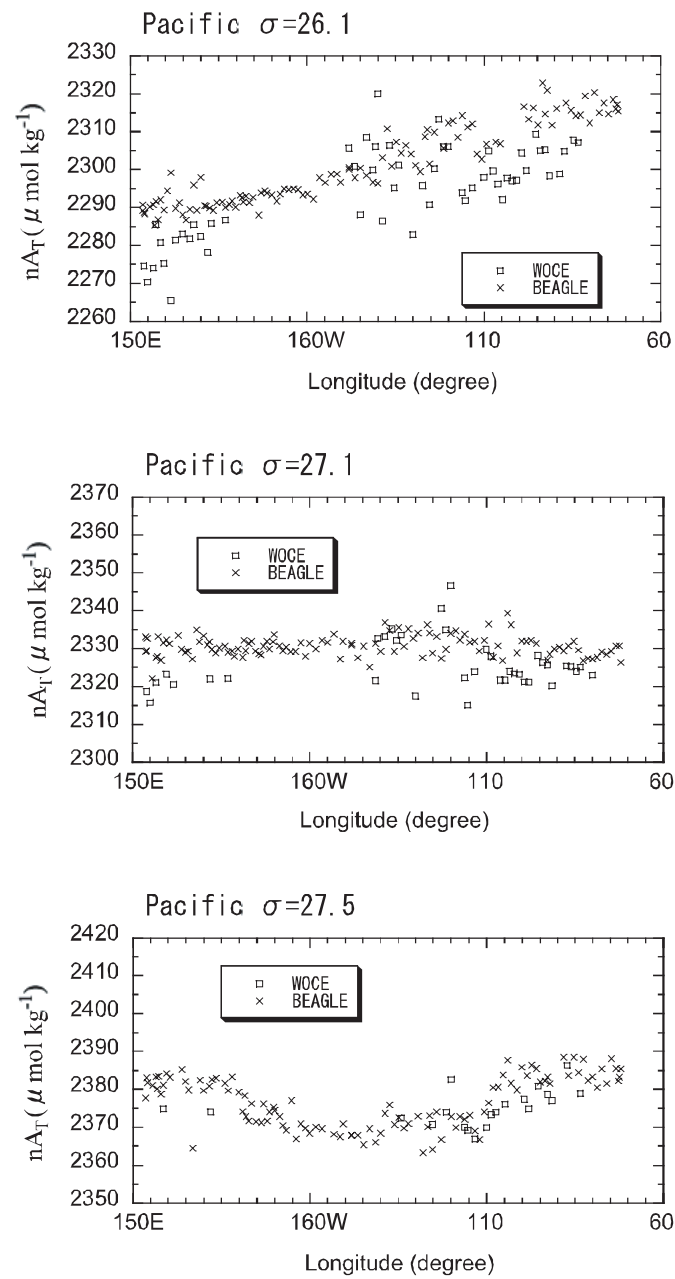

Figure 3.6.5. Comparisons of A_T measured in the BEAGLE with A_T calculated from C_T and $p\text{CO}_2$ measured along the WOCE P6 on isopycnal surfaces of $26.1 \sigma_\theta$ (top panel), $27.1 \sigma_\theta$ (middle panel) and $27.5 \sigma_\theta$ (bottom panel).

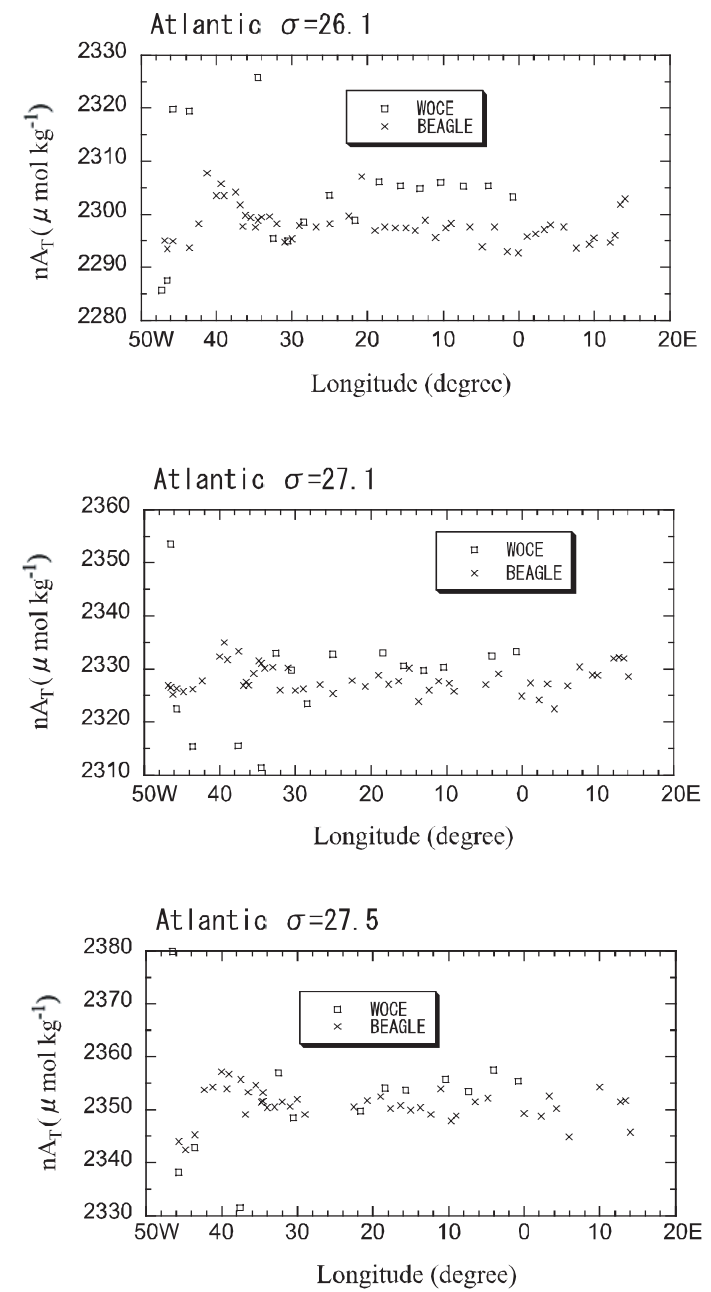

Figure 3.6.6. Comparisons of A_T measured in the BEAGLE with A_T calculated from C_T and $p\text{CO}_2$ measured along the WOCE A10 on isopycnal surfaces of $26.1 \sigma_\theta$ (top panel), $27.1 \sigma_\theta$ (middle panel) and $27.5 \sigma_\theta$ (bottom panel).

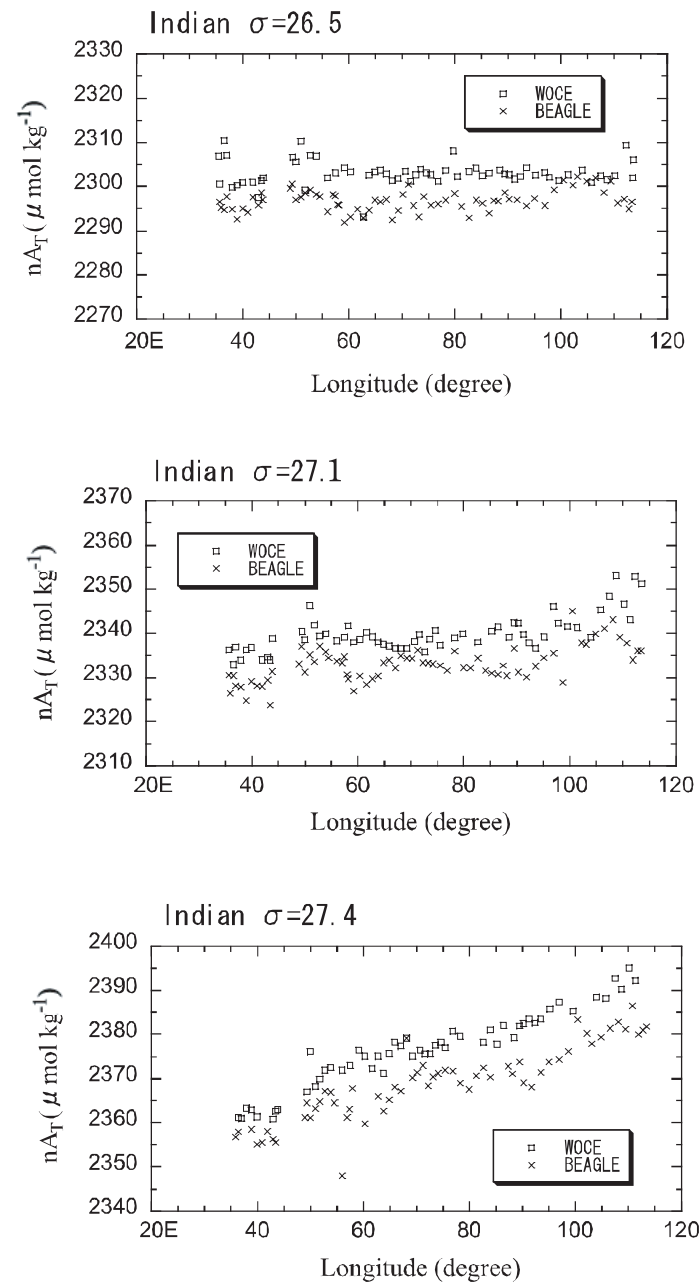

Figure 3.6.7. Comparisons of A_T measured in the BEAGLE with A_T calculated from C_T and $p\text{CO}_2$ measured along the WOCE I3/14 on isopycnal surfaces of $26.1 \sigma_0$ (top panel), $27.1 \sigma_0$ (middle panel) and $27.5 \sigma_0$ (bottom panel).

3.7 pH

3 February 2005

(1) Personnel

Akihiko Murata (IORGC, JAMSTEC)

Fuyuki Shibata (MWJ)

Taeko Ohama (MWJ)

(2) Introduction

Concentrations of CO₂ in the atmosphere are now increasing at a rate of 1.5 ppmv y⁻¹ due to human activities such as burning of fossil fuels, deforestation, cement production, etc. It is an urgent task to estimate as accurately as possible the absorption capacity of the oceans against the increased atmospheric CO₂, and to clarify the mechanism of the CO₂ absorption, because the magnitude of the predicted global warming depends on the levels of CO₂ in the atmosphere, and because the ocean currently absorbs 1/3 of the 6 Gt of carbon emitted into the atmosphere each year by human activities.

In the BEAGLE, we were aimed at quantifying how much anthropogenic CO₂ absorbed in the Southern Ocean, where intermediate and deep waters are formed, are transported and redistributed in the southern hemisphere subtropical oceans. For the purpose, we measured CO₂-system properties such as dissolved inorganic carbon (C_T), total alkalinity (A_T), pH and underway pCO₂.

In this section, we describe data on pH obtained in the BEAGLE in detail.

(3) Apparatus

Measurement of pH was made by a pH measuring system (Nippon ANS, Inc.), which adopts a method of the spectrophotometric determination. The measuring system comprises of a water dispensing unit with an auto-sampler and a spectrophotometer (Carry 50 Scan, Varian).

Seawater is transferred from borosilicate glass bottle (300 ml) to a sample cell in the spectrophotometer. The length and volume of the cell are 8 cm and 13 ml, respectively, and the sample cell is kept at 25.00 ± 0.05 °C in a thermostatic compartment. First, absorbance of seawater is measured at three wavelengths (730, 578 and 434 nm). Then an indicator solution is injected and circulated for about 4 minutes to mix the indicator solution and seawater sufficiently by a peristaltic pump. After the pump is stopped, the absorbance of seawater + indicator solution is measured at the three wavelengths. The pH is calculated based on the following equation (Clayton and Byrne, 1993):

$$pH = pK_2 + \log \left(\frac{A_1 / A_2 - 0.00691}{2.2220 - 0.1331(A_1 / A_2)} \right), \quad (1)$$

where A₁ and A₂ indicate absorbance at 578 and 434 nm, respectively, and pK₂ is calculated as a function of water temperature and salinity.

(4) Shipboard measurement

Sampling

All seawater samples were collected from depth with 12 liter Niskin bottles basically at every other stations. The seawater samples for pH were taken with a plastic drawing tube (PFA tubing connected to silicone rubber tubing) into a 300 ml borosilicate glass bottle, which is the same as used for C_T sampling. The glass bottle was filled with seawater smoothly from the bottom following a rinse with a sea water of 2 full, bottle volumes. The glass bottle was closed by a stopper, which was fitted to the bottle mouth gravimetrically without additional force.

We analyzed seawater samples as soon as possible within half a day.

Analysis

For an indicator solution, m-cresol purple (2 mM) was used. NaCl was added to the indicator solution so that

the solution had a density close to seawater. The indicator solution was produced on board the ship, and retained in a 1000 ml DURAN® laboratory bottle. To minimize absorption of CO₂ in an indicator solution, a holder of soda lime was attached. We renewed an indicator solution periodically when the headspace of the bottle became large, and monitored pH or absorbance ratio of the indicator solution by another spectrophotometer (Carry 50 Scan, Varian) using a cell with a short path length of 0.5 mm. In most indicator solutions, the absorbance ratios were initially in the range 1.4 – 1.6, and decreased to 1.1.

It is difficult to mix seawater with an indicator solution sufficiently under no headspace condition. However, by circulating the mixed solution with a peristaltic pump and by increasing density of indicator solutions, a well-mixed condition came to be attained rather shortly, leading to a rapid stabilization of absorbance (Fig. 3.7.1). We renewed a TYGON® tube of a peristaltic pump periodically, when the tube deteriorated in an impaired condition.

Absorbance of seawater only and seawater + indicator solutions was measured 12 and 30 times, respectively, and the last five values of absorbance were used for the calculation of pH (Equation 1).

The preliminary values of pH were reported in a data sheet on the ship. Repeatability calculated from replicate samples and vertical profiles of pH based on raw data for each station helped us check performance of the measuring system.

In each leg, we finished all the analyses for pH on board the ship. We did not encounter so serious a problem as we had to give up the analyses. However, we sometimes experienced malfunction of the system during the cruise:

The difference between absorbance of seawater only and absorbance of seawater + indicator solution was infrequently greater than ± 0.001 . This implies dirt of the cell. In this case, we cleaned or replaced the cell.

(5) Quality control

It is recommended that correction for pH change resulting from addition of indicator solutions is made (DOE, 1994). To check the perturbation of pH due to the addition, we measured absorbance ratios by changing

the volume of indicator solutions added to a same seawater sample. We corrected absorbance ratios based on an empirical method (DOE, 1994).

We surveyed vertical profiles of pH. In particular, we examined whether systematic differences between before and after the renewal of indicator solutions existed or not. Then taking other information of analyses into account, we determined a flag of each value of pH.

The average and standard deviation of absolute values of differences of pH analyzed consecutively are listed in Table 3.7.1.

References

Clayton, T.D. and R.H. Byrne (1993): Spectrophotometric seawater pH measurements: total hydrogen ion concentration scale calibration of m-cresol purple and at-sea results. *Deep-Sea Research* 40, 2115-2129.
 DOE (1994): Handbook of methods for the analysis of the various parameters of the carbon dioxide system in sea water, version 2, A. G. Dickson & C. Goyet, eds. (unpublished manuscript).

Table 3.7.1. Averages and standard deviations (s.t.d.) of absolute values differences of pH analyzed consecutively, separately for legs 1, 2, 4 and 5.

Leg no.	N	Average	s.t.d
1	140	0.0014	0.0017
2	176	0.0017	0.0014
4	155	0.0010	0.0009
5	208	0.0008	0.0007

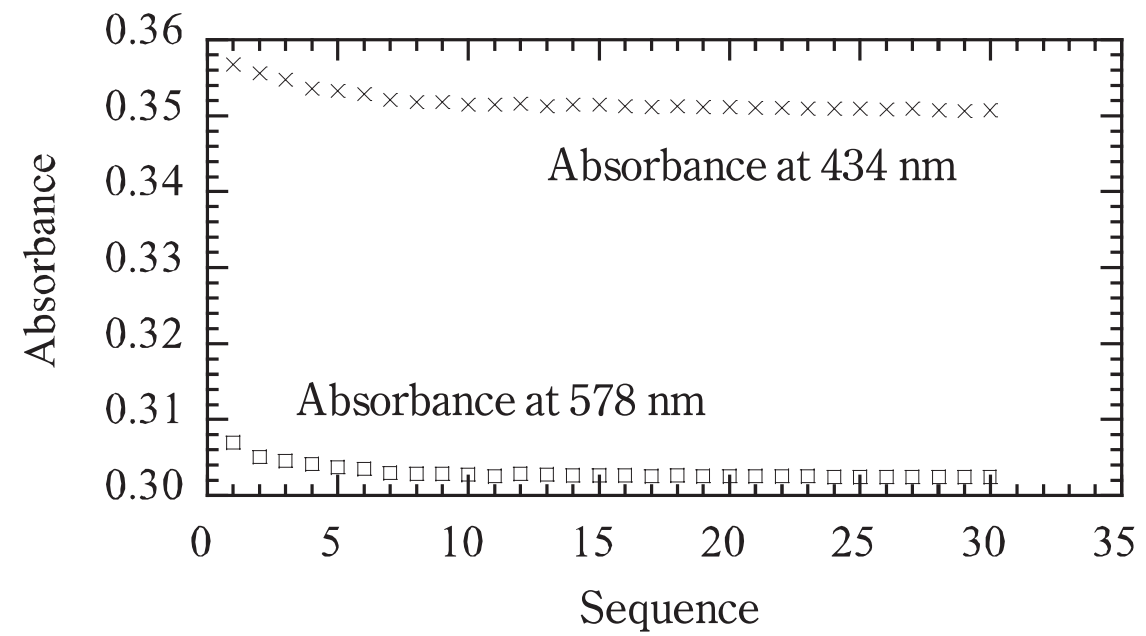

Figure 3.7.1. An example of temporal changes of absorbances. A unit of sequence corresponds to about 5 seconds.

3.8 Lowered Acoustic Doppler Current Profiler

28 February 2005

(1) Personnel

Yasushi Yoshikawa (JAMSTEC)

Luiz Nonnato (University of Sao Paulo)

On Sugimoto (JAMSTEC)

(2) Instrument and method

Direct flow measurement from sea surface to the bottom was carried out using a lowered acoustic Doppler current profiler (LADCP). The instrument used was the RDI Workhorse Monitor 307.2 kHz unit (RD Instruments, USA). The instrument was attached on the CTD/RMS frame, orientating downward. The CPU firmware version was 16.20.

One ping raw data were recorded, where the bin number was 32 and the bin length was 8 m, except 4m at CTD stations from P6_246 to P6_232 in the beginning of the cruise. The accuracies of each ping were 2.0 cm/s for 8 m bin and 3.0 cm/s for 4 m bin, respectively. Sampling interval was 1.29 seconds originally, and then it was changed to 1.20 seconds in leg 5. The bottom-tracking mode was used, which made the LADCP capture the sea floor 200 m above. Salinity value in the sound speed calculation was set as a constant value 34 PSU. We found the one of the four beams sounded weak signal during the cruise, and then we replaced another instrument at A10_37 station in the Atlantic sector. A pressure sensor was added to the first instrument.

A total of 118 operations were made with the CTD observations in the leg 1. Because the depth was too deep, operation was not made at the CTD stations, P6_175, P6_174 and P6_148. The performance of the LADCP instrument was good in western stations. Profiles were obtained over 100 m distance in shallow depth and almost 60 m in deeper depth. On the other hand in eastern stations in the leg 1 the performance was bad. In the deeper depth good quality data were obtained only 3 or 4 bins, which means the LADCP could observe

only 25 m. It would due to a weak echo intensity, which agreed with ship's ADCP. A total of 112 operations are made in the leg 2. In the leg 4 a total of 111 operations were made. As mentioned above, we replace the instrument at A10_37. For the first instrument, the performance was bad; profiles were obtained less than 60 m in deeper depth. Three beam solutions gradually appeared more, sometimes in the leg 1, and often in the leg 2 and leg 4 before the replacement. After the replacement the profile was obtained about 80 m in deeper depth, as a four-beam solution. The sea bottom was detected during the instrument was lowered less than 200 m above the bottom. A total of 142 operations were made in the leg 5. The LADCP measurement was not operated at the station I3_468 where the depth was too deep. The performance of the instrument was relatively better in the shallow ocean, where profiles were obtained over 100 m. In the deep ocean it reached almost 60 m. The performance looked unchanged during the leg. Data transfer errors were often occurred during upload process from the LADCP to PC.

(3) Preliminary results

Vertical profiles of velocity field are analyzed by the inverse method (Visbeck, 2002). The bottom-track data and GPS navigation data are used in the calculation. Shipboard ADCP data are not included in the calculation. At this stage the CTD data are used for the sound speed and depth calculation. Figure 3.8.1 and 3.8.2 show the results at station A10_087 and A10_010, respectively, in the Atlantic. They would be a typical good and bad result, respectively. The results are somewhat sensitive to parameters. It is probably due to the short range of the LADCP signal, which makes less overlap in the inversion. More three-beam solution should affect it worse. On the other hand the bottom tracking was valid even if the sound did not reach so long.

Reference

Visbeck, M. (2002): Deep velocity profiling using Lowered Acoustic Doppler Current Profilers: Bottom track and inverse solutions. *J. Atmos. Oceanic Technol.*, 19, 794-807.

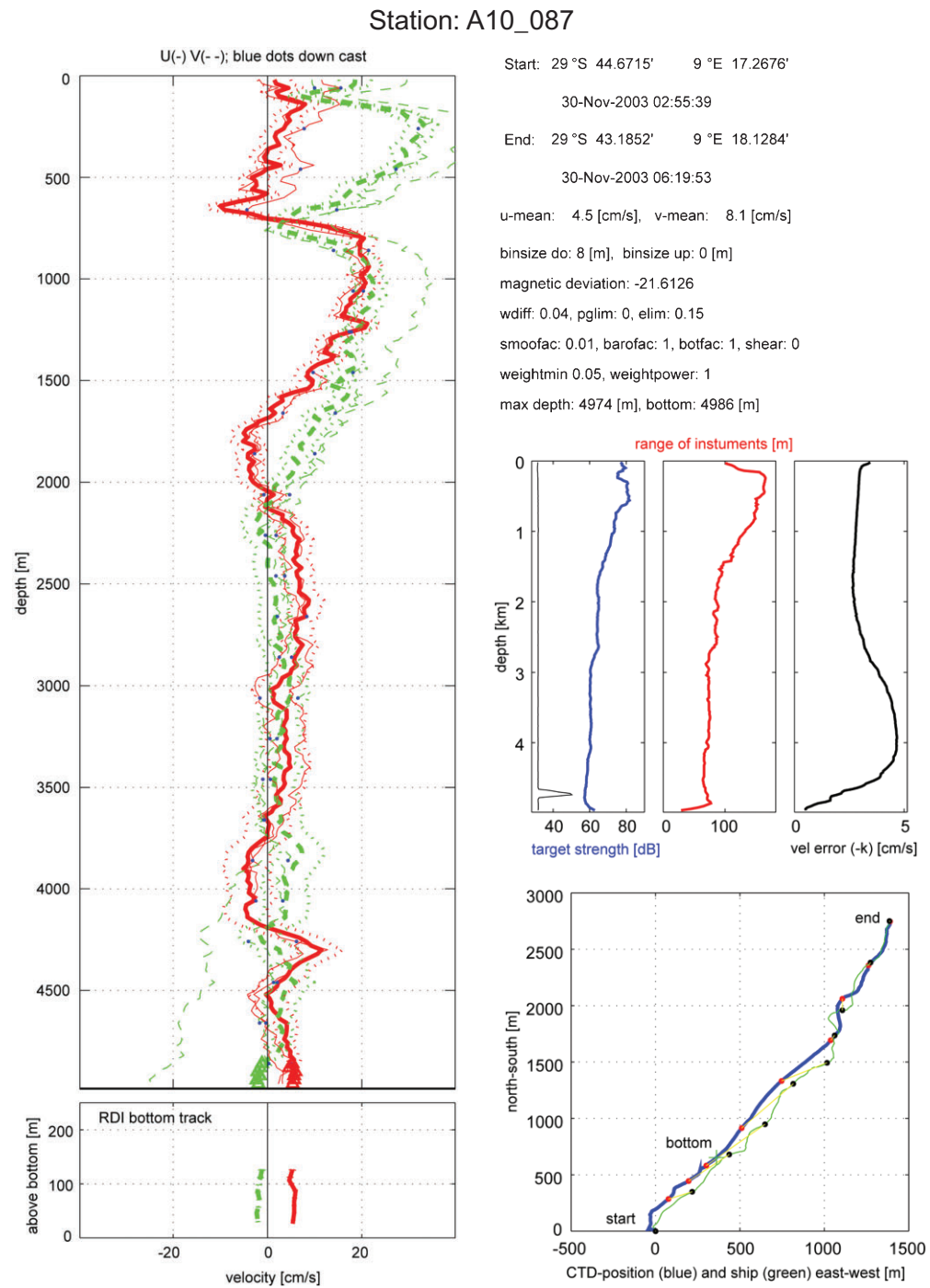

Figure 3.8.1. Vertical profiles of velocity at station A10_87.

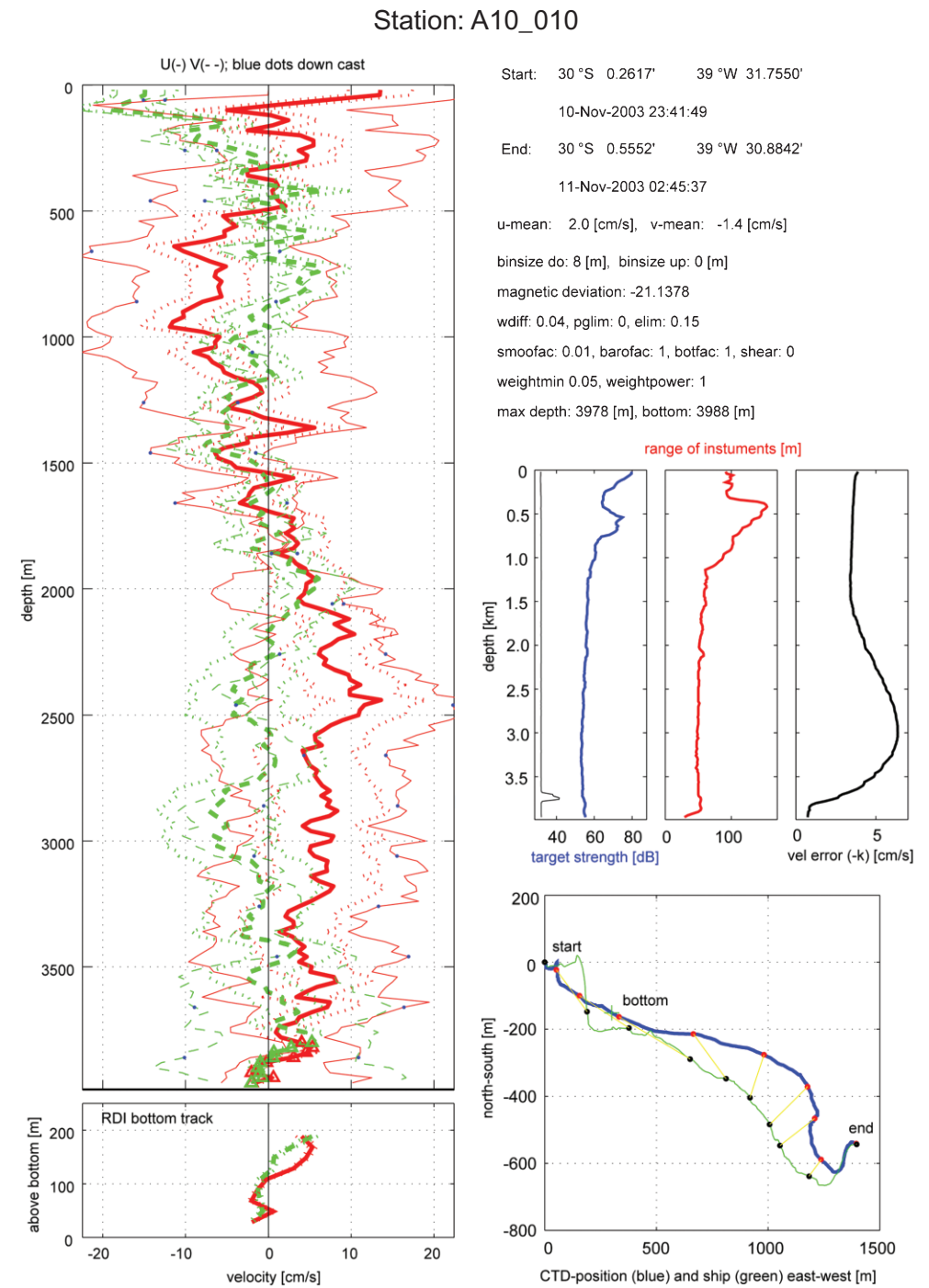

Figure 3.8.2. Vertical profiles of velocity at station A10_10.

Figure caption

- Figure 1 Observation lines for WHP P6, A10 and I3/I4 revisit in Blue Earth Global Expedition 2003 (BEAGLE2003) with bottom topography based on ETOPO5 (Data announcement 88-MGG-02, 1988).
- Figure 2 Station locations for WHP P6, A10 and I3/I4 revisit in BEAGLE2003 with bottom topography based on Smith and Sandwell (1997).
- Figure 3 Potential temperature ($^{\circ}\text{C}$) cross section calculated using CTD temperature and salinity data calibrated by bottle salinity measurements. Vertical exaggeration of the 0-6,500 m section is 1000:1. Expanded section of the upper 1000 m is made with a vertical exaggeration of 2500:1.
- Figure 4 CTD salinity (psu) cross section calibrated by bottle salinity measurements. Vertical exaggeration is same as Figure 3.
- Figure 5 Same as Figure 4 but with SSW batch correction¹.
- Figure 6 Density (σ_{θ}) (kg/m^3) cross section calculated using CTD temperature and calibrated salinity data with SSW batch correction. Vertical exaggeration is same as Figure 3.
- Figure 7 Same as Figure 6 but for σ_t (kg/m^3).
- Figure 8 Neutral density (γ^n) (kg/m^3) cross section calculated using CTD temperature and calibrated salinity data with SSW batch correction. Vertical exaggeration is same as Figure 3.
- Figure 9 Cross section of bottle sampled dissolved oxygen ($\mu\text{mol}/\text{kg}$). Data with quality flags of 2 were plotted. Vertical exaggeration is same as Figure 3.
- Figure 10 Silicate ($\mu\text{mol}/\text{kg}$) cross section. Data with quality flags of 2 were plotted. Vertical exaggeration is same as Figure 3.
- Figure 11 Nitrate ($\mu\text{mol}/\text{kg}$) cross section. Data with quality flags of 2 were plotted. Vertical exaggeration of the upper 1000 m section is same as Figure 3.
- Figure 12 Nitrite ($\mu\text{mol}/\text{kg}$) cross section. Data with quality flags of 2 were plotted. Vertical exaggeration is same as Figure 3.
- Figure 13 Phosphate ($\mu\text{mol}/\text{kg}$) cross section. Data with quality flags of 2 were plotted. Vertical exaggeration is same as Figure 3.
- Figure 14 Dissolved inorganic carbon ($\mu\text{mol}/\text{kg}$) cross section. Data with quality flags of 2 were plotted. Vertical exaggeration is same as Figure 3.
- Figure 15 Total alkalinity ($\mu\text{mol}/\text{kg}$) cross section. Data with quality flags of 2 were plotted. Vertical exaggeration is same as Figure 3.
- Figure 16 pH cross section. Data with quality flags of 2 were plotted. Vertical exaggeration is same as Figure 3.
- Figure 17 Difference in potential temperature ($^{\circ}\text{C}$) between results from WOCE (from May to Jul. 1992 for P6, from Dec. 1992 to Jan. 1993 for A10, from Apr. to June 1995 for I3/I4) and BEAGLE2003 (from

Jul. to Oct. 2003 for P6, from Nov. to Dec. 2003 for A10, from Dec. 2003 to Jan. 2004 for I3/I4). Red and blue areas show areas where potential temperature increased and decreased in BEAGLE2003, respectively. On white areas differences in temperature do not exceed the detection limit of 0.002 °C. Vertical exaggeration is same as Figure 3.

Figure 18 Difference in salinity (psu) between results from WOCE and BEAGLE2003. Red and blue areas show areas where salinity increased and decreased in BEAGLE2003, respectively. CTD salinity data with SSW batch correction¹ are used. On white areas differences in salinity do not exceed the detection limit of 0.002 psu. Vertical exaggeration is same as Figure 3.

Figure 19 Difference in dissolved oxygen (μmol/kg) between results from WOCE and BEAGLE2003. Red and blue areas show areas where salinity increased and decreased in 2001, respectively. CTD oxygen data² are used. On white areas differences in salinity do not exceed the detection limit of 2 μmol/kg. Vertical exaggeration is same as Figure 3.

Note

1. As for the traceability of SSW to Mantyla's value, the offset for the batches P116 (WOCE P6), P120 (WOCE A10), P126 (WOCE I3/I4) and P142 (BEAGLE2003) are +0.0001, -0.0022, -0.0007 and -0.0011, respectively (Aoyama et al, 2002, Aoyama, 2005).
2. As for the WOCE A10 data, there are systematic differences between CTD oxygen and bottle oxygen data (Millard, 2000). Therefore the CTD oxygen of WOCE A10 was modified as

$$\begin{aligned} \text{Modified CTD oxygen} &= \text{CTD oxygen} - (a_0 + b_0 * p) \text{ [where } p < 2,000 \text{ dbar]} \\ &= \text{CTD oxygen} - (a_1 + b_1 * p) \text{ [where } p \geq 2,000 \text{ dbar]} \\ a_0 + b_0 * pr &= a_1 + b_1 * pr \text{ [where } pr = 2,000 \text{ dbar]} \end{aligned}$$

where p is CTD pressure in dbar. The best fit sets of coefficients (a0, b0, a1 and b0) were determined by

minimizing the sum of absolute deviation from the bottle oxygen data as follows.

$$\begin{aligned} a_0 &= -3.9577e-4 \\ b_0 &= 6.4409 \\ a_1 &= 6.3317e-4 \\ b_1 &= 4.3830 \end{aligned}$$

References

Data Announcement 88-MGG-02 (1988): Digital relief of the Surface of the Earth, NOAA, National Geophysical Data Center, Boulder, Colorado.

Jackett, D. R. and R. J. McDougall (1997): A neutral density variable for the world's oceans, *Journal of Physical Oceanography*, 27, 237-263.

Smith, W. H. F. and D. T. Sandwell (1997): Global seafloor topography from satellite altimetry and ship depth soundings, *Science*, 277, 1956-1962.

Aoyama, M., T. M. Joyce, T. Kawano and Y. Takatsuki (2002): Standard seawater comparison up to P129, *Deep-Sea Res. I*, 49, 1103-1114.

Aoyama, M. (2005): Study on the traceability of reference material for salinity in seawater, Report of Research Project, Grant-in-Aid for Scientific Research (C)(2), 2002-2004, pp. 24.

Millard, R. (2000): DQE of CTD & water sample salinity and oxygen data of WOCE section A10, Cruise and data documentation for WHP A10, AR04EW, AR15, <http://whpo.ucsd.edu/data/onetime/atlantic/a10/index.htm>

